

SLO-SYN[®] Motion Control Products



SERVO CONTROLS

STEPPER CONTROLS

VOLTAGE CONDITIONING

ENGINEERED SYSTEMS

AC/DC DRIVES

Superior Electric

Motion Control Products

Superior Electric is internationally recognized as a leader in the manufacture of motion control equipment. The company has earned an enviable reputation for quality, coupled with unparalleled engineering and production facilities, placing it in a unique position of developing product lines for both new and existing high technology markets.

Superior Electric is expanding its motion control markets by introducing innovative, state-of-the-art products that go beyond competitive offerings. Refinements are constantly being made to keep abreast of existing technology to maintain Superior Electric's position of leadership.

We ship worldwide

Superior Electric SLO-SYN® products are available worldwide. Electro Sales offer literature, technical assistance and a wide range of models off the shelf for fastest possible delivery and service.

In addition, Superior Electric sales and application engineers are conveniently located to provide prompt attention to customers' needs. Call Electro Sales customer service for ordering and application information or for the address of the closest authorized distributor for Superior Electric's SLO-SYN® products.



Contents

| | Page |
|--|--------------|
| SLO-SYN® 2000 Motion Controls | 3 |
| Modular Drives | 4 |
| Packaged Drives | 5 |
| Controls | |
| SS2000MD4M-0, SS2000-OF, SS2000I | 6 |
| WARPDRIVE™ SS2000D3i/D6i, SS2000PCi | 7 |
| MX2000 (Programmable Multi-Axis Motion Controller) | 8 |
| TD/TDC/TDP (Brushless Servo Systems) | 9 |
| SERVO Amplifiers, Power Supplies and Motors | 10 |
| DCS Drive Control System | 11 |
| Programmable Operator Interface Panels | |
| IWS 30SE, IWS 127SE | 12 |
| Program Development Software | 13 |
| SLO-SYN® DC Step Motors | 14-22 |
| Gearheads for DC Step Motors | 23 |
| SLO-SYN® AC Synchronous Motors | 24-25 |
| SLO-SYN® AC Gearmotors | 26-27 |
| SLO-SYN® Servo Motors | 28-31 |

SLO-SYN[®] 2000

Motion Controls

The newest series of Superior Electric motion controls, the SLO-SYN 2000, is designed for maximum versatility and ease of use. The product lineup includes both modular and packaged Programmable Motion Controls, which can be combined with a variety of modular, or packaged drives offering motor phase current ratings from 0.5 to 12 amperes. An Oscillator/Analog Speed Follower also is offered for applications where the speed of a step motor must be controlled by an analog signal.

The most recent addition to the SLO-SYN 2000 Series is the WARPDRIVE™ SS2000D3i series of step-motor positioning systems which provide a microstepping controller and drive in one convenient compact package.

NEW WARPDRIVE™ SS2000D3i

The SS2000D3i step motor positioning system is a 3 ampere version of the SS2000D6i. It includes all the same features found in the SS2000D6i, including the new SS2000D3 drive, an integral positioning controller with BASIC-like language programming and power supply in one package.

The SS2000D3i provides switch selectable motor currents from 0.5 to 3 amperes and will work with all SLO-SYN standard & high torque NEMA 23 and 34 size motors.

Also joining the Warpdrive family is the new compact SS2000PCi Programmable Step Motor Controller. The SS2000PCi single axis packaged step motor controller is a fully programmable digital indexer (controller) and power supply in one compact high-powered package.

Programming the position controller is done via a Windows Based graphical interface and uses the same language as Superior Electric's popular versatile TDC and MX2000 controllers. The New MotionWriter™ point & click graphical user interface is available for use in programming SS2000D3i/D6i, SS2000PCi, and TDC controllers.

In addition, the SS2000MD4M-O Micro Step Drive/Oscillator has been added to the SLO-SYN family. It combines a bipolar, two-phase PWM drive and a control/oscillator in one compact unit.

Superior also offers Programmable Operator Interface Panels which provide a convenient, intelligent user interface to a motion control system. They use BASIC-like coding, and are programmable using a user-friendly utility program which runs on IBM compatible Personal Computers.



Standard SLO-SYN 2000 Design Features

- Designed for “bulletproof” operation, ease of use
- UL and CUL Recognition (on most models)
- CE Compliance (on most models)
- Built-in ac line filter and MOV's
- Filtered inputs (optical isolation on most models)
- IEC 1000-4-4, standard for electrical fast transient ("noise") immunity
- Wide design margins and component de-rating for long life and greater reliability
- Easy to use connectors (removable screw-clamp type on most models)
- Front panel access for most switches and connectors
- Rugged, industrial-quality enclosures
- Clear, descriptive front panel labels for ease of wiring and operation
- Easy to set up and operate
- Cables and software supplied with most models

SLO-SYN[®] 2000

Motion Controls

Modular Drives

SLO-SYN 2000 Modular Drives are open-frame units or have small enclosures, and require an external dc power source. They are generally used where the drive will become an integral part of the user's system, or in multi-axis systems utilizing a common power supply.

SD200

- Low cost, high quality OEM drive
- 0.5 to 2.5 amperes motor current
- Full- or half-step operation
- Operates KML060 through KML091 and M061 through M091 motors
- Printed circuit board mount
- Compact, modular design
- 12 to 40 VDC bus voltage

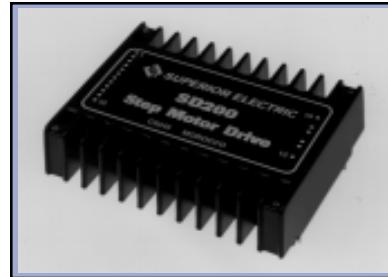

SS2000MD4 and SS2000MD4-M

- For full/half-step (SS2000MD4) or microstep (SS2000MD4-M operation)
- 0.5 to 3.5 amperes motor current (switch selectable)
- Operate KML060 through KML092 and M061 through M092 motors
- Integral heat sink
- Full short circuit protection
- 24 to 40 VDC bus voltage

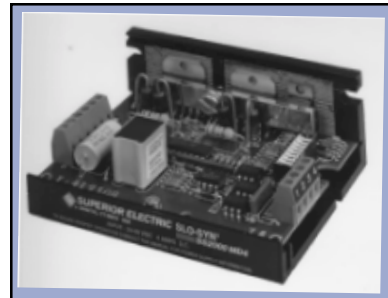

S2000MD7 and SS2000MD7-128

- Switch selectable Micro Steps
MD7 — 1/2, 1/10, 1/25, 1/100
MD7-128 — Full Step, 1/16, 1/64, 1/128
- Motor current from 1.0 through 7 amperes, switch selectable
- Operate KML060 through KML093 and M061 through M093 motors
- 24 to 75 VDC bus voltage
- UL Recognized, CE Compliant



MD808 and MD808-128

- Switch selectable Micro Steps
MD808 — Full, 1/2, 1/5, 1/10, 1/20, 1/25, 1/50, 1/100
MD808-128 — Full, 1/2, 1/4, 1/8, 1/16, 1/32, 1/64, 1/128
- Motor current from 3.0 through 8 amperes, switch selectable with auto-reduce at standstill
- Operate KML060 thru KML093 and M061 thru M093 motors
- Active stabilization for improved motor performance
- 24 to 80 VDC bus Voltage
- UL Recognized, CE Compliant



SLO-SYN[®] 2000

Motion Controls

Packaged Drives

A packaged drive is a stand-alone unit which operates directly from an ac power source and is packaged in a full enclosure.

SS2000DP4

The latest addition to the SLO-SYN family of packaged drives is the SS2000DP4. It is a compact Unit Containing (2) 3.5 amp step motor drives with integral power supply.

- 115/230VAC input with line fuses and MOV protection
- Switch selectable current levels of 1.0 through 3.5 amps
- Pulse and direction control
- CW/CCW input capability
- Full short circuit protection (phase-to-phase and phase-to-ground)
- Undervoltage and transient overvoltage protection
- Overtemperature protection
- Efficient thermal design
- Optically isolated inputs
- "Windings Off" Capability
- Automatic Current Reduction (In -MM models)
- Switch selectable step
- Sturdy all-aluminum mounting base



SS2000D3/D6

- Switch selection of full/half-steps or microstep resolution up to 50,000 pulses/rev.
- Switch selectable motor current from 1 through 6 amperes for the SS2000D6, 0.5 through 3 amperes for the SS2000D3
- SS2000D3 operates KML060-KML091 and M061-M092 motors
- SS2000D6 operates KML060-KML093 and M061-MH112 motors
- "Bullet-proof", fully protected design
- 120 VAC input, 180 VDC bus voltage
- UL Recognized for use in US and Canada
- CE Compliant



SS2000D12

- Switch selection of full/half-steps or microsteps
- Switch selectable motor current from 2 through 12 amperes
- Operates KMT093 and M111 thru MH172 motors
- Up to 4 kW motor output power
- "Bullet-proof", fully protected design
- 120 or 230 VAC input
- Up to 350 VDC bus voltage
- UL Recognized for use in US and Canada
- CE Compliant



SLO-SYN[®] 2000

Motion Controls

SS2000MD4M-O

The SS2000MD4M-O combines all the features of the SS2000MD4M microstepping modular drive and a digital control/oscillator in one compact package. The MD4M-O is ideal for OEM and multi-axis applications utilizing a single power supply.



- Microprocessor-based Digital Oscillators for accurate speed control
- Built-in potentiometers for acceleration, deceleration, low speed, and run speed
- Switch selectable motor current levels of 1.0 to 3.5 amperes
- Full short circuit protection (phase-to-phase and phase-to-ground)
- Under voltage and transient over-voltage protection
- Efficient thermal design, with built-in heatsink
- Windings off capability
- User selectable automatic current reduction at standstill
- Run speed control from built-in potentiometer or external voltage input

SS2000OF

The SS2000OF can be used wherever the speed of a step motor must be altered to match changing conditions or must be synchronized with that of another element of the system. It has been designed to meet the same construction requirements as other units of the SLO-SYN 2000 Series, and offers features that make it suited for use in a wide variety of applications.

- Compatible with all SLO-SYN step motor drives and most other pulse and direction drives
- Adjustable potentiometer controls output pulse rate, allowing variable speed control of a step motor system
- Can be controlled by a 4 to 20 milliamperes current level, a 0 to 10 volt analog signal or a -10 to +10 VDC differential voltage



SS2000I Packaged Programmable Motion Control

SS2000I-V Closed-Loop Programmable Motion Control

The SS2000I and SS2000I-V are high performance, programmable motion controls specifically designed for use with SS2000D6 and SS2000D12 drives. They can also be used with any other SLO-SYN step motor drives as well as with most standard pulse and direction drives, including digital servo drives. The controls can be used to operate one drive, or they can operate two drives, **one-at-a-time**, in applications where simultaneous motion is not needed.

The SS2000I is an open-loop control, which can be easily converted to closed-loop operation in the field by replacing the memory module with an optional closed-loop module. The SS2000I-V is shipped from the factory with the closed-loop module in place.

- Two axes of motion (one at a time)
- Separate acceleration and deceleration
- Velocity changes "on the fly"
- Breakpoint programming
- Choice of trapezoidal, "S" curve, or hyperbolic ramp profiles
- Mark registration accurate to ± 1 microstep
- Pulse outputs to 48 MHz
- Abundant, versatile, bulletproof I/O
- 16 inputs, 8 outputs
- Short-circuit proof outputs
- Built-in 24 VDC, 0.75 A power supply for I/O
- 400 lines of user program stored in BRAM
- Serial port, RS232 or RS 485 to 9600 baud
- Up to 2 BCD switch banks
- Optional External I/O capability
- IEC 801-4, Level III noise immunity
- UL Recognized, CE compliant
- Operates from 90 - 265 VAC, 50/60 hertz input



SLO-SYN[®] 2000

Motion Controls

WARPDRIVE[™] SS2000D3i/D6i Packaged Motor Controller and Drive

The most recent addition to the SLO-SYN 2000 Series is the WARPDRIVE[™] SS2000D3i/D6i series of step-motor positioning systems which provide a microstepping controller and drive in one convenient compact package.

The SS2000D3i/D6i step motor positioning systems include all of the superior features of the SS2000D3/D6 drive, an integral-positioning controller with BASIC-like language programming and a power supply in one package.

This versatile system will work with standard SLO-SYN step motors in size NEMA 23 to NEMA 42 and SLO-SYN High Torque Motors in sizes NEMA 23 and NEMA 34.

The integral programmable controller utilizes a patent-pending digital microstepping current control technique to provide smooth motor performance.

Programming the position controller is done via a Windows Based graphical interface and uses the same language as Superior Electric's popular versatile TDC and MX2000 controllers. In addition the New MotionWriter[™], point and click graphical user interface is available for use with the SS2000D3i/D6i positioning systems.

- Packaged drive, control and power supply
- 100-120V \pm 10% AC input
- Utilizes robust SS2000D3/D6 drive design
- Motor phase current selectable up to 6 amps (D6i)
- Simplified motor selection
- Short-circuit Protection
- Optically isolated I/O, 8 Inputs, 4 Outputs
- Windows based software development utility for easy programming on any PC
- Easy to use BASIC - like programming language
- Additional 8 inputs and 4 outputs, non-isolated
- 16 bit microprocessor
- Encoder input for closed loop operation (differential or single ended)
- One 0-10V analog input (10 bit resolution)
- BCD interface with separate connector
- 2 serial ports, RS232 / 485 up to 38K baud
- Built-in ac line filter and MOV's for transient protection
- Patent-pending digital microstepping current control
- Smoother motor operation at low speeds
- Meets IEC 1000-4-4 standard for electrical fast transient ("noise") immunity
- UL recognized and CE compliant
- Optional terminal board for easy wiring



WARPDRIVE[™] SS2000PCi Packaged Programmable Indexer

The SLO-SYN SS2000PCi fully programmable single axis digital indexer (controller) is the newest member of the WARPDRIVE family. The SS2000PCi with its open chassis design and built-in power supply is a low cost alternative for a wide variety of OEM, multi-axis, and stand alone applications.

Programming the digital Indexer is done via a Windows based graphical interface (included) which uses the same programming language as Superior Electric's popular SS2000D6i and MX2000 controllers. The New MotionWriter[™] software program is available for use with the SS2000PCi. Other features include:

- High performance Motion Controller with 16-bit, 16 MHz microprocessor
- Easy setup programming with Windows Interface and BASIC-like language
- Optional point & click graphical user interface, MotionWriter[™] software avail.
- 8 inputs, 4 outputs of optically isolated I/O
- 8 inputs, 4 outputs of non-isolated I/O
- One 0-10V analog input, 10 bit resolution
- Encoder input for closed loop operation (differential or single ended)
- 2 serial ports, RS232/485 up to 38K baud
- RS485 daisy chaining capability, up to 32 units
- Built-in AC line filter and MOV's for transient protection
- Meets IEC 1000-4-4 standard for noise immunity
- UL Recognized, CE pending



SLO-SYN[®] 2000

Motion Controls

MX2000 Programmable Multi-Axis Motion Controller

The MX2000 is a powerful, DSP-based controller that can be configured for controlling up to eight axes, and provides fully coordinated motion control, including linear and circular interpolation and splining. It can be easily incorporated into the user's machine control system. The multi-tasking capability of the MX2000 enables it to scan I/O as a PLC, independent of motion. In many cases, an MX2000 can serve as the only controller required in a complex, sophisticated control system.

The MX2000 provides all of the functions and features expected from a sophisticated motion control product. These include a stepper interface (pulse rates to 2 Mhz) compatible with drives providing rates to 50,000 pulses per second (1/250 microstepping); Axis inputs; Analog outputs; Encoder Interface to support up to eight axes; Expansion-BCD I/O; and a Serial Data Interface for communications to a host computer or operator interface panel. Flexible modular construction offers three enclosure configurations to meet user's unique requirements. These configurations are as follows:

MX-2 for 2 axes; MX-6 for up to 6 axes; MX-8 for up to 8 axes

The newest additions to the MX2000 series of Multi-axis controls are the MX2000-1C, MX2000-2A, and MX2000-6A. The MX-1C is a card level 1-2 axis controller designed for OEM applications. The MX-2A and MX-6A versions employ a new power supply card which provides a digital I/O interface in place of the standard I/O - BCD interface.



- Fully coordinated motion control, including linear and circular interpolation and splining
- Programmable using WINDOWS based BASIC-like software (included) coding, optional icon driven software utilities, or CAD-To-Motion which converts a DXF file to motion control commands.

- Full math functions including Trig, Logs and Square Roots
- Subroutine capability (up to 16 levels)
- Multi-tasking of up to 7 concurrent tasks
- Up to 8 servo axes, or 8 axes of stepper pulse and direction outputs, with Boost and Reduce
- Up to 8 axes of Encoder inputs (2 Mhz max.) and analog I/O
- Up to 16 analog inputs and 8 analog outputs
- Optional Isolation with built-in 24 VDC 0.75 amp power supply for I/O power
- 90-265 VAC, 50/60 hertz input including built-in line filter with MOV
- Battery backed RAM (up to 10 years using lithium battery cell)
- 2 independent serial ports operating at up to 38 Kbaud
- PLC emulation
- 126 kbytes user memory
- Flash EPROM operating system – can be upgraded through serial port
- Modular design
- Up to 352 I/O points – can be scanned independent of motion algorithms
- Up to 32 BCD banks
- Sink or source I/O
- Up to 32 high speed trigger inputs for mark registration and homing functions
- UL recognized

SLO-SYN[®] 2000

Motion Controls

TD/TDC/TDP Series Brushless Servo Systems

The **SLO-SYN TD** series of Brushless DC servo amplifiers provide a superior, cost effective transition from stepper to servo performance.



The **TD** servo products are stand alone, compact servo amplifiers with integral, line operated, power supply.

The **TD** servo amplifier operates directly off the AC line with input voltages from 95 to 264 VAC, 50/60 Hz. They are designed to drive brushless DC servo motors utilizing either Hall effect devices or encoders with commutation tracks.

Available in two model configurations, the **TD330/04** provides output currents of 4 amps continuous /8 amps peak, while the **TD330/08** provides 8 amps continuous, 16 amps peak. Both operate with a bus voltage of up to 330 VDC for optimum speed/torque performance. Continuous stall torques range from 5 lb-in to 120 lb-in, with peak torques double that of continuous. Depending on the motor/drive combination, speeds up to 5000 RPM are available when using the SLO-SYN LIS/HIS servo motors.

The **SLO-SYN TDC** series of brushless servo positioning systems are the perfect solution to replace a stepper mo-

tor system with servo performance in a compact, cost effective package. Applications once earmarked for stepper systems can now be upgraded to the highest levels of performance using true, closed loop, brushless DC servo control and motors.

The **TDC** servo positioning system is a completely integrated system, including all of the superior features of the **TD** servo amplifier, an integral positioning controller with BASIC-like language programming, and power supply in one compact package. MotionWriter™ point & click software is also available for use with **TDC** and **TDP** systems.

TDC brushless servo systems are available in two model configurations, **TDC 330/04** and **TDC 330/08**. Each model provides the same features as its **TD330/04**, **TD330/08** counterpart.

The **TDP** pulse input Servo Amplifier is the newest addition to our brushless DC servo system family. The **TDP** is the solution where servo performance is demanded and a stepper type control is desired. The **TDP** is a packaged servo amplifier and power supply capable of accepting pulse position commands and driving brushless DC servo motors.

As with the **TD** and **TDC** the **TDP** is available in two models, the **TDP330/04** and **TDP330/08**. Each model provides the same specifications as the comparable **TD** amplifier.

TD Features

- Continuous current ratings of 4 amps and 8 amps (8 and 16 amps peak)
- Compatible with most Brushless DC Servo motors using Hall effect devices or encoders with commutation tracks
- Systems provide typical torque outputs from 5 lb-in to 120 lb-in
- Line operated 95-264 VAC input, no external power supply required
- Switch selectable current scaling for easy installation (no potentiometers to adjust)
- Latched short circuit protection (phase-to-phase and phase-to-ground)
- Latched over temperature protection
- Latched DC bus over voltage protection
- Conventional +/-10VDC Analog Input
- LED indicators for over voltage, over current, over temp, and power regeneration
- 50 ohm 50 watt regenerative energy circuit included.
- Provision for external regeneration resistors
- UL Recognized
- CE Compliant

TDC Features

- The following features are in addition to the features already listed for the TD amplifier.
- 16 bit microprocessor
 - Differential or Single ended Encoder Input
 - 2 Serial ports, RS232/485 up to 38 kBaud
 - Optically isolated I/O, 10 inputs, 2 outputs, sink or source selectable
 - Additional 8 inputs and 4 outputs, non-isolated
 - Auto tuning of servo gains
 - One +/- 10V differential analog input, 10 bits
 - BASIC-like programming language.
 - Complete Windows-based Software development utility for easy programming on any PC included
 - Built-in BCD interface with separate connector
 - Separate Busy and Fault LED indicators

TDP Features

- 16 bit microprocessor
- Scalable pulses per motor revolution (Step Angle)
- 3 pulse formats
 - Pulse and Direction
 - CW Pulse and CCW Pulse
 - A/B Quadrature
- Normal or Buffered (Burst) Pulse input
- Manages servo control of shaft position
- PC based configuration program
- Configuration parameters and Auto tuning on one easy to follow screen
- Pre-configured inputs
 - ±Limit switch inputs (may be disabled)
 - Pulse inhibit
 - Torque limit enable
 - Soft drive enable
 - Reset fault

SLO-SYN[®] 2000

Motion Controls

Servo Amplifiers, Power Supplies and Motors

Throughout the SLO-SYN 2000 Servo product line, you'll find the quality you expect, and the performance you require.

With torque and power densities unsurpassed by competitive models, SLO-SYN products help you maintain the highest possible levels of performance while providing you with maximum flexibility for single and multiple axis control.

Brushless **Servo Motors** employ resolver feedback and are precisely matched to our line of Servo amplifiers. With 23 standard motors to choose from, and torque ratings from 7.44 in-lb to 396 in-lb continuous (up to 834 in-lb peak) you can select the Servo Motor that most closely matches your performance requirements.

SLO-SYN **Servo Amplifiers** present you with a wide range of peak power ratings of 6 to 110 amps RMS. These 3-phase, sine wave, brushless amplifiers incorporate a built-in microprocessor which implements a patented torque angle control for maximum torque at high speeds.

When the job calls for **multi-axis (2-8) control**, our MX2000 Motion Controller is ready to respond. This high performance multi-tasking system incorporates Texas Instruments' TMS320C31 floating point, 32-bit, 33MHz digital signal processor (DSP).

Anchoring your SLO-SYN Servo system is a broad choice of **Power Supply units**. The modular design of SLO-SYN Servo's is ideally suited for multi-axis systems. And, for ease of installation include pre-configured jumper cables that connect your Servo system in seconds. Our modular Servo system design reduces power consumption and resistor size when used in multi-axis and web tensioning systems.

Our Servo motion control systems rely on integral **resolver** (vs. encoder) feedback for greater instantaneous starting torque and exceptionally reliable performance under high temperatures and extreme vibration. As such, our systems are ideally suited for use in even the toughest of industrial environments.

For the ultimate in safety and reliability, Servo Amplifiers provide solid protection against overloads, ground faults, short circuits, and high temperature operation.

So why not unleash the power and performance of a SLO-SYN Servo motion control system today. And realize its many inherent benefits for years to come.



Features

Servo Motors

- Neodymium-Iron-Boron (Ne Fe B) Magnets
- Built-in Resolver
- Standard NEMA Mounting
- IP65 Sealing (Std.) IP67 Optional
- UL Recognized
- Over-Temperature Sensing
- Highest Acceleration/Deceleration Capabilities
- Designed for Operation in Harsh Industrial Environments
- Long Life Design

- Smooth Low-speed Performance
- Small Package
- Numerous Optional Configurations

Servo Amplifiers

- Resolver Based System for Maximum Performance and Reliability
- Modular Design for Reduced Cost Multi-axis Applications
- Built-in Overload Protection
- Available with Built-in, Packaged, 1-2 Axis Control
- Easy to Understand

- Diagnostic LED's
- Encoder Output Option
- High Bandwidth
- Quiet Operation
- Precision Torque or Speed Control
- Increased Motor Performance
- 6 to 110 Amps Peak
- UL Listed

Servo Power Supply

- Direct Line Voltage Input
- Shunt Overload Protection
- Soft Start
- Multiple Amplifier Operation
- UL Listed

SLO-SYN[®] 2000

Motion Controls

DCS Programmable Drive Control System

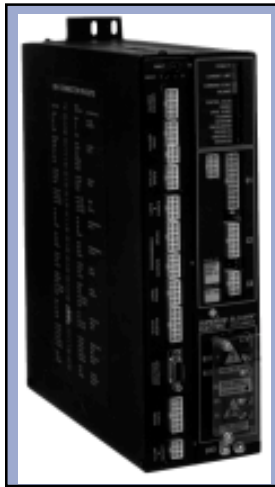

Superior Electric has developed a complete line of Control-Amplifiers (DCS units, Drive Control System) that incorporate MX2000 control technology. The Control-Amplifier unit consists of an MX2000 control card and amplifier (6 to 80 amps RMS) in one package. Each control-amplifier can operate an additional amplifier or stepper drive for a complete 2 axis system.

In addition the MX2000-1C (MX1) control card is available separately for use in OEM applications requiring a powerful one or two axis control.

WINDOWS-based software simplifies programming from a host computer through a serial data port. The software contains numerous screens so you can quickly and easily establish your system parameters. Plus, with built-in subroutine and looping (nestable up to 16 levels), your programming flexibility is greatly enhanced.

For ease of communicating with the controller, two serial ports are provided. The host port is switch-selectable for either RS232 or RS485 protocol, with a switch-selectable baud rate of 4800, 9600, 19.2K, or 38.4K. The auxiliary serial port is factory set for RS232 protocol, and is jumper configurable for RS485. This port has a factory set baud rate of 9600 but can be software adjusted up to 38.4 Kbaud.

With full servo and following capabilities, the **DCS** facilitates easy-to-program servo gains and on-screen servo auto-tuning with oscilloscope simulation, while providing a complete selection of following commands.

With torque and power densities unsurpassed by competitive models, SLO-SYN products help you maintain the highest possible levels of performance while providing you with maximum flexibility for single and dual axis control.

Let us show you how our Control Amplifier technology can handle all of your machine control requirements.

Features

Amplifier

- Resolver Based System for Maximum Performance and Reliability
- Built-in Overload Protection
- Easy to Understand Diagnostic LED's
- Encoder Output Option
- High Bandwidth
- Quiet Operation
- Precision Torque or Speed Control
- Increased Motor Performance
- 6 to 80 Amps Peak

Control

- Control integrated with servo amplifier; Can control a second, stand-alone (optional) servo amplifier or stepper drive
- Full Coordinated motion control including linear interpolation of 2 axes, circular interpolation and polynomial splining (with 2 axes)
- Programmable using WINDOWS-based BASIC-like coding software (included) or an optional icon driven software utility.
- Full math functions includ-

ing Trig, Logs, and Square roots

- Subroutine capability (up to 16 nested levels)
- Multi-tasking of up to 7 concurrent tasks
- All I/O is optically isolated, with built-in 24 VDC 0.75 amp power supply for I/O power
- Flash Memory enhances ease of programming and firmware updates
- 2 serial ports, operating at up to 38 Kbaud
- Auto-tuning of all Servo Gains

SLO-SYN[®] 2000

Motion Controls

Programmable Operator Interface Panels

IWS 30SE, IWS 120SE, and IWS 127SE

The IWS 30SE, IWS 120SE, and IWS 127SE Operator Interface Panels offer ideal solutions for versatile interfacing between the operator and a machine control system. All models are programmable using a BASIC type programming language and a user friendly utility program which runs on IBM compatible Personal Computers. Each Operator Interface has a sealed membrane keyboard, alpha-numeric display, Flash EPROM (IWS 30SE) or battery-backed RAM (IWS 127SE) program memory. The IWS 30SE has one serial port for communications with the motion system; while the IWS 127SE has three serial printer ports, one parallel printer port and an I/O bus connection port. The I/O bus can control up to 128 OPTO 22 style discrete I/O points via a daisy chain of sixteen 8-position OPTO 22 style module racks. These I/O points can be used to monitor/control machine interfaces such as material count, production quantities and other machine related I/O points.



IWS 120SE, IWS 127SE



IWS 30SE

In addition the IWS 120SE is now available. This operator Interface panel operates as a "dumb" terminal which can easily be interfaced to control systems. The MX2000 programmable multi-axis motion control is provided with software which will facilitate interfacing to this panel.

- Programmable using Windows based interface and BASIC-like coding
- 2-line x 20 characters/line LCD display on IWS 30SE
- 4-line x 20 characters/line VFD display on IWS 127SE
- Sealed membrane keyboard with steel domes
- RS232/422/485 Serial Ports (1 on IWS 30SE, 3 on IWS 127SE)
- Program security
- Auto Starting programs
- Flash EPROM on IWS 30SE
- Battery-backed RAM and Clock (up to 6 years using lithium battery cell) on IWS 127SE

SLO-SYN[®] 2000 Motion Controls

Program Development Software

Several software packages are available for developing application programs to accomplish required operations with SLO SYN programmable motion controls. The MS1 software is intended for application program development for the SPI700 Programmable Indexer and 440 Series Programmable Indexers. The MS2000 software (pictured) is for use with SLO-SYN SS2000I Programmable Motion Controls. The Panelworks software is used with the IWS family of Programmable Operator Interface panels. The MX2000 Windows-based software simplifies programming of the MX2000, DCS, and TDC families of multi-axis motion control products. In addition the new Motion Controller Programming Interface (MCPI) is now available for use with the WARPDRIVE[™] SS2000D6i Programmable Step Motor Controller Drive. All are provided with the applicable product on 3.5" floppy disks and are for use on IBM PC compatible computers.



[CAD-To-Motion Software for Windows](#)

The MX2000 CAD-To-Motion software enables the user to "draw" their motion profile using standard CAD packages. The software then converts the CAD files, stored in a DXF file format, into an MX2000 task file.

MX2000 CAD-To-Motion displays the drawing and copies the DXF data into three tables named lines, polylines, and arcs/circles. When the user selects an item in one of the tables, the item is converted into MX2000 SEBASIC code and is shown in the task file edit window. The contents of the edit window are then saved and imported into the MX2000 programming environment as a task file.

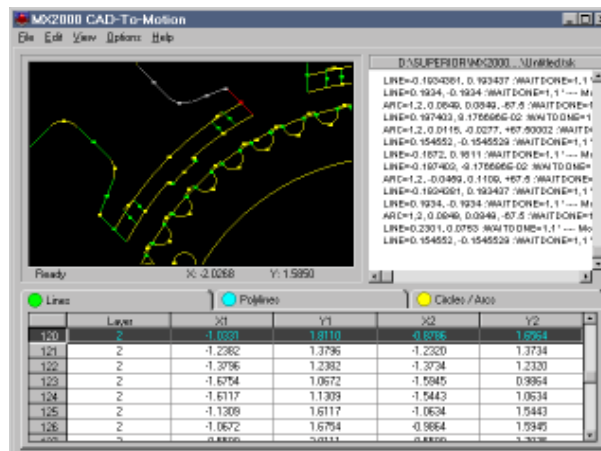

MotionWriter[™] Point & Click Programming Software

The latest addition to the Superior Electric Programming family is the MotionWriter[™] "Point and Click" programming software for Warpdrive[™] Series stepper controls and TDC/TDP Servo Positioning Systems.

MotionWriter[™] provides:

- Programming ease with eight pre-configured program templates
- Four step system configuration
- Generates SEBasic code at the click of a button
- Automatic tuning for TDC/TDP Servo Systems



SLO-SYN[®] DC Step Motors

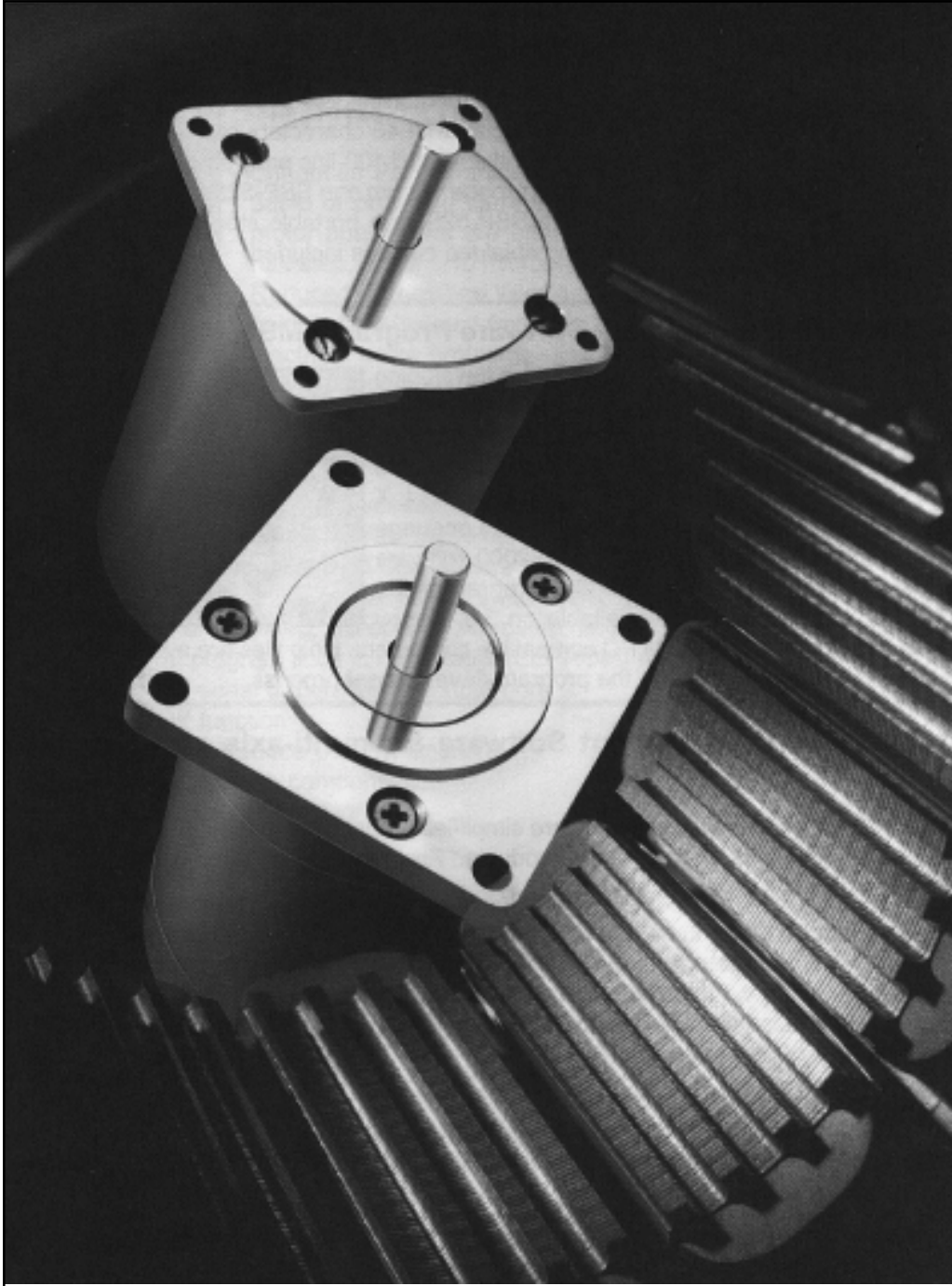

SLO-SYN[®] DC Step Motors

What is a Step Motor?

Step motors are devices which position loads by operating in discrete increments, or steps, unlike servo motors and other devices that operate at constant speed. The stepping action is accomplished by switching the power to the motor windings so that the motor phases are energized in a specific sequence. Stepper motors are capable of very precise positioning without the use of complicated and expensive feedback devices, although feedback systems may be incorporated into step motor systems if position comparison is desired. Because of the simplified control needs and the freedom from expensive feedback requirements, step motors have become viable alternatives to pneumatic, hydraulic and servo motor systems.

SLO-SYN DC Step Motors

SLO-SYN DC Step Motors are brushless, permanent magnet motors that have a full-step increment of 1.8°. They can also be made to operate in increments of 0.9° to 0.0144° when half-stepping or microstepping techniques are employed. Because they are digital devices, SLO-SYN DC Step Motors are easily adapted to different types of control and are ideal for use with microprocessor based systems.

SLO-SYN DC Step Motors are offered in a wide range of torque ratings, shaft configurations and frame sizes. Their unique combination of operating features and characteristics have made them the industry standard for industrial automation, scientific applications and office systems.

Construction

SLO-SYN Step Motors have permanent magnet rotors and eight-pole stators. They do not have brushes, ratchets or detents to wear out and they use shielded, lubricated-for-life ball bearings to insure maximum reliability and long life. Tests indicate a typical minimum life of five years.

The motors are totally enclosed, but are not sealed against direct splash of water, oil or other liquids. When the operating environment includes direct splash of water, oil, cutting fluids, etc., the motors should be protected from exposure to the fluids.

NOTE: M112-FJ and M112-FF motor models are sealed against ingress of liquids and dust per I.E.C.IP-56.

Temperature

SLO-SYN motors have Class B winding insulation and, therefore, may be operated at ambient temperatures from -40°C to +40°C (-40°F to +104°F). The continuous duty temperature rise is 65°C (149°F). Motor shell temperature must not be allowed to exceed 100°C (212°F).

Speed Capability

The performance of a step motor depends to a great extent on the control circuit used to drive the motor. With an appropriately designed control circuit, a SLO-SYN step motor can be operated at rates to 20,000 steps per second (6000 rpm).

SLO-SYN[®] DC

Step Motors

Step Angle

When the full-step switching sequence is used, the motor step angle is 1.8°, with accuracies of ±5% and ±3% available. Use of the half-step switching sequence gives a step angle of 0.9°. When microstepping is employed, increments as small as 0.0072° are possible. Stepping accuracy is noncumulative, so no matter how many steps are taken, the final position will never be more than 5% or 3% of one full step from the intended position.

Holding Torque

Standard models are available in holding torque ratings from 60 to 5330 oz-in (42.4 to 3764 Ncm) with both windings energized.

Underwriters Laboratories Recognition

All motors of the M06 Series are recognized by Underwriters Laboratories.

Motors in other series which comply with all requirements of Underwriters Laboratories component recognition program are identified with letter U suffixes to their type numbers. Eligible motors include most standard models, as well as double ended versions. Special OEM application motors built to customer specifications usually conform with requirements for bearing the U suffix but some, due to special construction features, may not qualify.

Motors included in the component recognition program were examined as Class A (105°C) insulating systems and are only recognized as such. Therefore, motors having the letter U suffix must be identified as having Class A insulation. However, insulating materials used on many motors, and on most OEM specials, are listed in the UL Component Recognition Directory as being suitable for 130°C (Class B insulation). Motors not having the letter U suffix, and therefore not recognized under the component program, bear the marking "Class B insulation" on their labels.

Motors supplied from a Class 2 source (UL Standard 506, paragraphs 40.1 and 42.1) are considered by UL in the examination of the end-use products suitability for recognition, whether the motor is or is not recognized under the component program.

Operation

SLO-SYN Step Motors operated on phase-switched dc power. The motor shaft advances in steps of 1.8° (200 steps per revolution) when a four-step (full-step mode) input sequence is used and in steps of 0.9° (400 steps per revolution) when an eight-step (half-step mode) input sequence is used. Use of microstepping techniques allows step increments as small as 0.0072° (50,000 steps per revolution).

60mm (NEMA 23) RATINGS and SPECIFICATIONS

| MOTOR TYPE 3% ACCURACY | CONNECTIONS | | TYPICAL TIME FOR SINGLE STEP (mS) | UNIPOLAR CONFIGURATION | | | | | | BIPOLAR CONNECTIONS | | | | | | | | | | | |
|---------------------------|-------------|-------|-----------------------------------|------------------------|---------------------------|--|---|------------------------|-------|------------------------------------|-------|-------|---------|---------------------|-------|-------|---------|-------|-------|------------------------------------|-----|
| | | | | NOMINAL DC VOLTS (3) | RATED AMPERES PER WINDING | NOMINAL RESISTANCE PER WINDING (25°C) OHMS (2) | NOMINAL INDUCTANCE PER PHASE (MILLI-HENRYS) (2) (4) | MINIMUM HOLDING TORQUE | | SERIES CONNECTION | | | | PARALLEL CONNECTION | | | | | | | |
| | | | | | | | | | | MINIMUM HOLDING TORQUE OZ-IN (Ncm) | | VOLTS | AMPERES | R | L | VOLTS | AMPERES | R | L | MINIMUM HOLDING TORQUE OZ-IN (Ncm) | |
| | NUMBER | TYPE | | 2Ø ON | 1Ø ON | 2Ø ON | 1Ø ON | 2Ø ON | 1Ø ON | 2Ø ON | 1Ø ON | 2Ø ON | 1Ø ON | 2Ø ON | 1Ø ON | 2Ø ON | 1Ø ON | | | | |
| M061-CE02 | 8 | CONN. | 2.5 | 5 | 1 | 5 | 9.57 | 60 | 36 | 7 | 0.7 | 10 | 38.3 | 75 | 45 | 3.54 | 1.4 | 2.5 | 9.57 | 75 | 45 |
| M061-LE02 | 8 | LEADS | 2.5 | 5 | 1 | 5 | 9.57 | 60 | 36 | 7 | 0.7 | 10 | 38.3 | 75 | 45 | 3.54 | 1.4 | 2.5 | 9.57 | 75 | 45 |
| M061-CS02 | 6 | CONN. | 2.5 | 5 | 1 | 5 | 9.57 | 60 | 36 | 7 | 0.7 | 10 | 38.3 | 75 | 45 | — | — | — | — | — | — |
| M061-LS02 | 6 | LEADS | 2.5 | 5 | 1 | 5 | 9.57 | 60 | 36 | 7 | 0.7 | 10 | 38.3 | 75 | 45 | — | — | — | — | — | — |
| M061-CE08 | 8 | CONN. | 2 | 1.25 | 3.8 | 0.33 | 0.635 | 60 | 36 | 1.8 | 2.7 | 0.66 | 2.54 | 75 | 45 | 0.89 | 5.4 | 0.165 | 0.635 | 75 | 45 |
| M061-LE08 | 8 | LEADS | 2 | 1.25 | 3.8 | 0.33 | 0.635 | 60 | 36 | 1.8 | 2.7 | 0.66 | 2.54 | 75 | 45 | 0.89 | 5.4 | 0.165 | 0.635 | 75 | 45 |
| M061-CS08 | 6 | CONN. | 2 | 1.25 | 3.8 | 0.33 | 0.635 | 60 | 36 | 1.8 | 2.7 | 0.66 | 2.54 | 75 | 45 | — | — | — | — | — | — |
| M061-LS08 | 6 | LEADS | 2 | 1.25 | 3.8 | 0.33 | 0.635 | 60 | 36 | 1.8 | 2.7 | 0.66 | 2.54 | 75 | 45 | — | — | — | — | — | — |
| M061-FF-206 | 4 | LEADS | — | — | — | — | — | — | — | 6.3 | 1 | 6.3 | 24.8 | 75 | — | — | — | — | — | — | — |
| M061-CS-301* | 6 | CONN. | 7.5 | 11 | 0.44 | 22.5 | 38.4 | 53 | 32 | 15.6 | 0.3 | 45 | 154 | 65 | 39 | — | — | — | — | — | — |
| M061-LS-301* | 6 | LEADS | 7.5 | 11 | 0.44 | 22.5 | 38.4 | 53 | 32 | 15.6 | 0.3 | 45 | 154 | 65 | 39 | — | — | — | — | — | — |
| M061-CS-302* | 6 | CONN. | 4.2 | 5.5 | 0.88 | 6.2 | 9.57 | 53 | 32 | 7.7 | 0.6 | 12.4 | 38.3 | 65 | 39 | — | — | — | — | — | — |
| M061-LS-302* | 6 | LEADS | 4.2 | 5.5 | 0.88 | 6.2 | 9.57 | 53 | 32 | 7.7 | 0.6 | 12.4 | 38.3 | 65 | 39 | — | — | — | — | — | — |
| M061-CS-311* | 6 | CONN. | 12 | 20 | 0.22 | 91 | 126 | 47 | 28 | 28.3 | 0.16 | 182 | 504 | 58 | 35 | — | — | — | — | — | — |
| M061-LS-311* | 6 | LEADS | 12 | 20 | 0.22 | 91 | 126 | 47 | 28 | 28.3 | 0.16 | 182 | 504 | 58 | 35 | — | — | — | — | — | — |
| M061-CF-408 | 4 | CONN. | — | — | — | — | — | — | — | 8 | 0.5 | 15.9 | 61 | 75 | 45 | — | — | — | — | — | — |
| M061-LR-408 | 4 | LEADS | — | — | — | — | — | — | — | 8 | 0.5 | 15.9 | 61 | 75 | 45 | — | — | — | — | — | — |
| M062-CS03 | 6 | CONN. | 3.5 | 5.3 | 1.6 | 3.3 | 8.28 | 100 | 60 | 7.5 | 1.13 | 6.6 | 33.12 | 125 | 75 | — | — | — | — | — | — |
| M062-LS03 | 6 | LEADS | 3.5 | 5.3 | 1.6 | 3.3 | 8.28 | 100 | 60 | 7.5 | 1.13 | 6.6 | 33.12 | 125 | 75 | — | — | — | — | — | — |
| M062-CS04 | 6 | CONN. | 2.8 | 4.2 | 1.9 | 2.2 | 5.89 | 100 | 60 | 5.9 | 1.34 | 4.4 | 23.56 | 125 | 75 | — | — | — | — | — | — |
| M062-LS04 | 6 | LEADS | 2.8 | 4.2 | 1.9 | 2.2 | 5.89 | 100 | 60 | 5.9 | 1.34 | 4.4 | 23.56 | 125 | 75 | — | — | — | — | — | — |
| M062-CF04 | 8 | CONN. | 2.8 | 4.2 | 1.9 | 2.2 | 5.89 | 100 | 60 | 5.9 | 1.34 | 4.4 | 23.56 | 125 | 75 | 3 | 2.7 | 1.1 | 5.89 | 125 | 75 |
| M062-LE04 | 8 | LEADS | 2.8 | 4.2 | 1.9 | 2.2 | 5.89 | 100 | 60 | 5.9 | 1.34 | 4.4 | 23.56 | 125 | 75 | 3 | 2.7 | 1.1 | 5.89 | 125 | 75 |
| M062-CS06 | 6 | CONN. | — | 2.6 | 3.1 | 0.88 | 2 | 100 | 60 | 3.9 | 2.2 | 1.76 | 8 | 125 | 75 | — | — | — | — | — | — |
| M062-LS06 | 6 | LEADS | — | 2.6 | 3.1 | 0.88 | 2 | 100 | 60 | 3.9 | 2.2 | 1.76 | 8 | 125 | 75 | — | — | — | — | — | — |
| M062-CE06 | 8 | CONN. | — | 2.6 | 3.1 | 0.88 | 2 | 100 | 60 | 3.9 | 2.2 | 1.76 | 8 | 125 | 75 | 1.9 | 4.4 | 0.44 | 2 | 125 | 75 |
| M062-LE06 | 8 | LEADS | — | 2.6 | 3.1 | 0.88 | 2 | 100 | 60 | 3.9 | 2.2 | 1.76 | 8 | 125 | 75 | 1.9 | 4.4 | 0.44 | 2 | 125 | 75 |
| M062-CS09 | 6 | CONN. | 2.2 | 1.65 | 4.7 | 0.35 | 0.8 | 100 | 60 | 2.3 | 3.3 | 0.7 | 3.2 | 125 | 75 | — | — | — | — | — | — |
| M062-LS09 | 6 | LEADS | 2.2 | 1.65 | 4.7 | 0.35 | 0.8 | 100 | 60 | 2.3 | 3.3 | 0.7 | 3.2 | 125 | 75 | — | — | — | — | — | — |
| M062-CE09 | 8 | CONN. | 2.2 | 1.65 | 4.7 | 0.35 | 0.8 | 100 | 60 | 2.3 | 3.3 | 0.7 | 3.2 | 125 | 75 | 1.2 | 6.65 | 0.175 | 0.8 | 125 | 75 |
| M062-LE09 | 8 | LEADS | 2.2 | 1.65 | 4.7 | 0.35 | 0.8 | 100 | 60 | 2.3 | 3.3 | 0.7 | 3.2 | 125 | 75 | 1.2 | 6.65 | 0.175 | 0.8 | 125 | 75 |
| M062-FF-206 | 4 | LEADS | — | — | — | — | — | — | — | 4.2 | 1.5 | 2.8 | 12.5 | 125 | — | — | — | — | — | — | — |
| M062-CF-402 | 4 | CONN. | — | — | — | — | — | — | — | 6.6 | 1 | 6.6 | 33 | 125 | 75 | — | — | — | — | — | — |
| M062-LF-401 | 4 | LEADS | — | — | — | — | — | — | — | 6.6 | 1 | 6.6 | 33 | 125 | 75 | — | — | — | — | — | — |
| M063-CE06 | 8 | CONN. | 2.6 | 3.36 | 2.9 | 1.16 | 2.85 | 150 | 90 | 4.9 | 2.1 | 2.32 | 11.4 | 190 | 115 | 2.4 | 4.1 | 0.58 | 2.85 | 190 | 115 |
| M063-LE06 | 8 | LEADS | 2.6 | 3.36 | 2.9 | 1.16 | 2.85 | 150 | 90 | 4.9 | 2.1 | 2.32 | 11.4 | 190 | 115 | 2.4 | 4.1 | 0.58 | 2.85 | 190 | 115 |
| M063-CS06 | 6 | CONN. | 2.6 | 3.36 | 2.9 | 1.16 | 2.85 | 150 | 90 | 4.9 | 2.1 | 2.32 | 11.4 | 190 | 115 | — | — | — | — | — | — |
| M063-LS06 | 6 | LEAD | 2.6 | 3.36 | 2.9 | 1.16 | 2.85 | 150 | 90 | 4.9 | 2.1 | 2.32 | 11.4 | 190 | 115 | — | — | — | — | — | — |
| M063-CE09 | 8 | CONN. | 2.4 | 2.25 | 4.6 | 0.49 | 1.15 | 150 | 90 | 3.2 | 3.25 | 0.98 | 4.6 | 190 | 115 | 1.6 | 6.5 | 0.245 | 1.15 | 190 | 115 |
| M063-LE09 | 8 | LEADS | 2.4 | 2.25 | 4.6 | 0.49 | 1.15 | 150 | 90 | 3.2 | 3.25 | 0.98 | 4.6 | 190 | 115 | 1.6 | 6.5 | 0.245 | 1.15 | 190 | 115 |
| M063-CS09 | 6 | CONN. | 2.4 | 2.25 | 4.6 | 0.49 | 1.15 | 150 | 90 | 3.2 | 3.25 | 0.98 | 4.6 | 190 | 115 | — | — | — | — | — | — |
| M063-LS09 | 6 | LEADS | 2.4 | 2.25 | 4.6 | 0.49 | 1.15 | 150 | 90 | 3.2 | 3.25 | 0.98 | 4.6 | 190 | 115 | — | — | — | — | — | — |
| M063-FF-206 | 4 | LEADS | — | — | — | — | — | — | — | 5.4 | 1.5 | 3.6 | 14.5 | 190 | — | — | — | — | — | — | — |
| M063-CF-401 | 4 | CONN. | — | — | — | — | — | — | — | 5.66 | 1 | 5.66 | 29 | 160 | 96 | — | — | — | — | — | — |
| M063-LF-401 | 4 | LEADS | — | — | — | — | — | — | — | 5.66 | 1 | 5.66 | 29 | 160 | 96 | — | — | — | — | — | — |

(1) With 24 volts drive.

(2) Values shown are for reference only and are correct to the best of our knowledge at the time of publication, but are subject to change without notice. Parameters to be used as part of a specification should be verified with the factory.

(3) Voltage shown is per phase at rated current at zero steps per second, with winding at 25°C. Resistance tolerance and winding temperature will influence voltage.

(4) Tolerance is ±20%. Measured at 1 kHz with a General Radio #1650B impedance bridge having a 1 volt rms open circuit sinusoidal signal. Rotor position preconditioned by energizing same phase, then deenergizing same phase during measurement without changing rotor position.

* These motors are obsolete and should not be used in a new application design. They can be provided to support existing systems.

90mm Frame Size Model (NEMA Size 34D) RATINGS and SPECIFICATIONS

| MOTOR TYPE | | CONNECTIONS | | UNIPOlar CONFIGURATION | | | | | | | BIPOlar CONNECTIONS | | | | | | | | | | | |
|------------|-----------------|-------------|-------|---------------------------------------|----------------------|---------------------|--|---|------------------------|-------|---------------------|---------|-------|-------|------------------------------------|-------|---------------------|---------|-------|------|------------------------------------|-------|
| | | | | TYPICAL TIME FOR SINGLE STEP (mS) (1) | NOMINAL DC VOLTS (3) | AMPERES PER WINDING | NOMINAL RESISTANCE PER WINDING (25°C) OHMS (2) | NOMINAL INDUCTANCE PER PHASE (MILLI-HENRYS) (2) (4) | MINIMUM HOLDING TORQUE | | SERIES CONNECTION | | | | MINIMUM HOLDING TORQUE OZ-IN (Ncm) | | PARALLEL CONNECTION | | | | MINIMUM HOLDING TORQUE OZ-IN (Ncm) | |
| | | | | | | | | | 2Ø ON | 1Ø ON | VOLTS | AMPERES | R | L | 2Ø ON | 1Ø ON | VOLTS | AMPERES | R | L | 2Ø ON | 1Ø ON |
| — | M091-FD03 | 6 | LEADS | 8.5 | 5.3 | 1.6 | 3.3 | 16.5 | 150 | 90 | 7.25 | 1.1 | 6.6 | 66 | 180 | 110 | — | — | — | — | — | — |
| M091-FC06 | M091-FD06 | 6 | LEADS | 3.9 | 2.6 | 3.1 | 0.85 | 4.12 | 150 | 90 | 3.75 | 2.2 | 1.7 | 16.5 | 180 | 110 | — | — | — | — | — | — |
| M091-FC09 | M091-FD09 | 6 | LEADS | 3.1 | 1.7 | 4.7 | 0.36 | 1.5 | 150 | 90 | 2.4 | 3.3 | 0.72 | 6 | 180 | 110 | — | — | — | — | — | — |
| — | M091-FF-206 | 4 | LEADS | — | — | — | — | — | — | — | 3 | 3 | 1 | 10.4 | 180 | — | — | — | — | — | — | — |
| — | M091-FF-401 | 4 | TERM. | — | — | — | — | — | — | — | 6.8 | 1 | 6.8 | 52 | 180 | 110 | — | — | — | — | — | — |
| — | M091-FD-8106 | 8 | LEADS | 3.9 | 2.6 | 3.1 | 0.85 | 4.12 | 150 | 90 | 3.75 | 2.2 | 1.7 | 16.5 | 180 | 110 | 1.9 | 4.4 | 0.425 | 4.12 | 180 | 110 |
| — | M091-FD-8009 | 8 | TERM. | 3.1 | 1.7 | 4.7 | 0.35 | 1.5 | 150 | 90 | 2.4 | 3.3 | 0.72 | 6 | 180 | 110 | 1.2 | 6.6 | 0.18 | 1.5 | 180 | 110 |
| — | M091-FD-8109 | 8 | LEADS | 3.1 | 1.7 | 4.7 | 0.35 | 1.5 | 150 | 90 | 2.4 | 3.3 | 0.72 | 6 | 180 | 110 | 1.2 | 6.6 | 0.18 | 1.5 | 180 | 110 |
| M092-FC08 | M092-FD08 | 6 | LEADS | 4 | 3 | 4 | 0.75 | 3.56 | 300 | 180 | 4.2 | 2.8 | 1.5 | 14.24 | 370 | 225 | — | — | — | — | — | — |
| M092-FC09 | M092-FD09 | 6 | LEADS | 3.9 | 2.5 | 4.6 | 0.55 | 2.76 | 300 | 180 | 3.6 | 3.25 | 1.1 | 11.04 | 370 | 225 | — | — | — | — | — | — |
| — | M092-FF-206 | 4 | LEADS | — | — | — | — | — | — | — | 4 | 4 | 1 | 11.5 | 370 | — | — | — | — | — | — | — |
| — | M092-FD-310 | 6 | TERM. | 3.9 | 1.56 | 6.8 | 0.23 | 1.28 | 300 | 180 | 2.2 | 4.8 | 0.46 | 5.12 | 370 | 225 | — | — | — | — | — | — |
| — | M092-FD-335(5)* | 6 | TERM. | 3.9 | 1.56 | 6.8 | 0.23 | 1.28 | 300 | 180 | 2.2 | 4.8 | 0.46 | 8.12 | 370 | 225 | — | — | — | — | — | — |
| — | M092-FF402 | 4 | TERM. | — | — | — | — | — | — | — | 3.4 | 2 | 1.7 | 16.6 | 325 | 195 | — | — | — | — | — | — |
| — | M092-FD-8008 | 8 | TERM. | 4 | 3 | 4 | 0.75 | 3.56 | 300 | 180 | 4.2 | 2.8 | 1.5 | 14.24 | 370 | 225 | — | — | — | — | — | — |
| — | M092-FD-8108 | 8 | LEADS | 4 | 3 | 4 | 0.75 | 3.56 | 300 | 180 | 4.2 | 2.8 | 1.5 | 14.24 | 370 | 225 | — | — | — | — | — | — |
| — | M092-FD-8009 | 8 | TERM. | 3.9 | 2.6 | 4.6 | 0.55 | 2.76 | 300 | 180 | 3.6 | 3.25 | 1.1 | 11.04 | 370 | 225 | 2.1 | 5.7 | 0.375 | 3.56 | 370 | 225 |
| — | M092-FD-8109 | 8 | LEADS | 3.9 | 2.5 | 4.6 | 0.55 | 2.76 | 300 | 180 | 3.6 | 3.25 | 1.1 | 11.04 | 370 | 225 | 1.8 | 6.5 | 0.275 | 2.76 | 370 | 225 |
| — | M092-FD-8114* | 8 | TERM. | 3.9 | 1.65 | 6.8 | 0.023 | 1.18 | 300 | 180 | 2.3 | 4.8 | 0.46 | 3.72 | 370 | 225 | 11.2 | 9.6 | 0.115 | 1.18 | 570 | 225 |
| M093-FC07 | M093-FD07 | 6 | LEADS | 6.3 | 4.3 | 3.5 | 1.22 | 7.87 | 450 | 270 | 6.1 | 2.5 | 2.44 | 31.48 | 550 | 330 | — | — | — | — | — | — |
| M093-FC11 | M093-FD11 | 6 | LEADS | 4.1 | 2.65 | 5.5 | 0.48 | 3.19 | 450 | 270 | 3.75 | 3.9 | 0.96 | 12.76 | 550 | 330 | — | — | — | — | — | — |
| M093-FC14 | M093-FD14 | 6 | LEADS | 3.4 | 2.27 | 7 | 0.325 | 2 | 450 | 270 | 3.2 | 5 | 0.648 | 8 | 550 | 330 | — | — | — | — | — | — |
| — | M093-FF-206 | 4 | LEADS | — | — | — | — | — | — | — | 3.85 | 4 | 0.96 | 12.76 | 550 | — | — | — | — | — | — | — |
| — | M093-FD-301* | 6 | TERM. | 3.4 | 1.54 | 11 | 0.14 | 0.85 | 450 | 270 | 2.2 | 7.8 | 0.28 | 3.4 | 550 | 300 | — | — | — | — | — | — |
| — | M093-FD-315(5)* | 6 | TERM. | 3.4 | 1.54 | 11 | 0.14 | 0.85 | 450 | 270 | 2.2 | 7.8 | 0.28 | 3.4 | 550 | 300 | — | — | — | — | — | — |
| — | M093-FF-402 | 4 | TERM. | — | — | — | — | — | — | — | 4.5 | 3 | 1.5 | 16.9 | 550 | 330 | — | — | — | — | — | — |
| — | M093-FD-8007* | 8 | TERM. | 6.3 | 4.3 | 3.5 | 1.22 | 7.87 | 450 | 270 | 6.1 | 2.5 | 2.44 | 31.48 | 550 | 330 | 3 | 4.95 | 0.61 | 7.87 | 550 | 330 |
| — | M093-FD-8107* | 8 | LEADS | 6.3 | 4.3 | 3.5 | 1.22 | 7.87 | 450 | 270 | 6.1 | 2.5 | 2.44 | 31.48 | 550 | 300 | 3 | 4.95 | 0.61 | 7.87 | 550 | 300 |
| — | M093-FD-8011 | 8 | TERM. | 4.1 | 2.64 | 5.5 | 0.48 | 3.19 | 450 | 270 | 3.75 | 3.9 | 0.96 | 12.76 | 550 | 300 | 1.9 | 7.8 | 0.24 | 3.19 | 550 | 330 |
| — | M093-FD-8014 | 8 | TERM. | 3.4 | 2.27 | 7 | 0.324 | 2 | 450 | 270 | 3.2 | 5 | 0.648 | 8 | 550 | 330 | 1.6 | 9.9 | 0.612 | 2 | 550 | 300 |

- (1) With 24 volts drive.
(2) Values shown are for reference only and are correct to the best of our knowledge at the time of publication, but are subject to change without notice. Parameters to be used as part of a specification should be verified with the factory.
(3) Voltage shown is per phase at rated current at zero steps per second, with winding at 25°C. Resistance tolerance and winding temperature will influence voltage.

- (4) Tolerance is $\pm 20\%$. Measured at 1 kHz with a General Radio #1650B impedance bridge having a 1 volt rms open circuit sinusoidal signal. Rotor position preconditioned by energizing same phase, then deenergizing same phase during measurement without changing rotor position.
(5) Has double end shaft.
* These motors are obsolete and should not be used in a new application design. They can be provided to support existing systems.

110mm (NEMA Size 42) & 165mm (NEMA Size 66) RATINGS and SPECIFICATIONS

| MOTOR TYPE 5% ACCURACY | CONNECTIONS | | TYPICAL TIME FOR SINGLE STEP (mS) (1) | UNIPOlar CONFIGURATION | | | | | | BIPOlar CONNECTIONS | | | | | | | | | | | |
|------------------------------|-------------|---------|--|------------------------|---------------------------|---|--|------------------------|-------|---------------------|-------|-------|-------|------------------------------------|-------|---------------------|---------|--------|------|------------------------------------|------|
| | | | | NOMINAL DC VOLTS (3) | RATED AMPERES PER WINDING | NOMINAL RESISTANCE PER WINDING (25°C) OHMS (2) | NOMINAL INDUCTANCE PER PHASE (MILLI-HENRYS) (2) (4) | MINIMUM HOLDING TORQUE | | SERIES CONNECTION | | | | MINIMUM HOLDING TORQUE OZ-IN (Ncm) | | PARALLEL CONNECTION | | | | MINIMUM HOLDING TORQUE OZ-IN (Ncm) | |
| | VOLTS | AMPERES | | | | | | | | R | L | 2Ø ON | 1Ø ON | | | VOLTS | AMPERES | R | L | | |
| | NUMBER | TYPE | | 2Ø ON | 1Ø ON | 2Ø ON | 1Ø ON | 2Ø ON | 1Ø ON | 2Ø ON | 1Ø ON | 2Ø ON | 1Ø ON | 2Ø ON | 1Ø ON | | | | | | |
| M111-FD12 | 6 | TERM. | 4.4 | 2.26 | 6.1 | 0.37 | 2.3 | 625 | 375 | 3.2 | 4.3 | 0.74 | 9.2 | 850 | 500 | — | — | — | — | — | — |
| M111-FD16* | 6 | TERM. | 4.4 | 1.7 | 8 | 0.21 | 1.1 | 625 | 375 | 2.4 | 5.7 | 0.42 | 4.4 | 850 | 500 | — | — | — | — | — | — |
| M111-FF-206 | 4 | TERM. | — | — | — | — | — | — | — | 3.5 | 5 | 0.7 | 9.2 | 760 | — | — | — | — | — | — | — |
| M111-FD-327* | 6 | TERM. | 7 | 4.1 | 3.5 | 1.17 | 7.2 | 625 | 375 | 5.85 | 2.5 | 2.34 | 28.8 | 850 | 500 | — | — | — | — | — | — |
| M111-FF-401 | 4 | TERM. | — | — | — | — | — | — | — | 4 | 3.4 | 1.14 | 17.7 | 850 | 500 | — | — | — | — | — | — |
| MX111-FF-401 | 4 | TERM. | — | — | — | — | — | — | — | 4 | 3.4 | 1.14 | 17.7 | 850 | 500 | — | — | — | — | — | — |
| M111-FD-8003* | 8 | TERM. | — | 6.93 | 1.55 | 4.47 | 26.2 | 625 | 375 | 9.8 | 1.1 | 8.94 | 105 | 850 | 500 | 4.9 | 2.2 | 2.24 | 26.2 | 850 | 500 |
| M111-FD-8007* | 8 | TERM. | 7 | 4.1 | 3.5 | 1.17 | 7.2 | 625 | 375 | 5.85 | 2.5 | 2.34 | 28.8 | 850 | 500 | 2.93 | 5 | 0.585 | 7.2 | 850 | 500 |
| M111-FD-8012 | 8 | TERM. | 4.4 | 2.26 | 6.1 | 0.37 | 2.3 | 625 | 375 | 3.2 | 4.3 | 0.74 | 9.2 | 850 | 500 | 1.6 | 8.63 | 0.185 | 2.3 | 850 | 500 |
| M111-FD-8016* | 8 | TERM. | 4.4 | 1.7 | 8 | 0.21 | 1.1 | 625 | 375 | 2.4 | 5.7 | 0.42 | 4.4 | 850 | 500 | 1.2 | 11.3 | 0.105 | 1.1 | 850 | 500 |
| M112-FD08* | 6 | TERM. | 7 | 5.8 | 3.8 | 1.53 | 14 | 1125 | 675 | 8.25 | 2.7 | 3.06 | 56 | 1390 | 830 | — | — | — | — | — | — |
| M112-FD12 | 6 | TERM. | 5.5 | 3.66 | 6.1 | 0.6 | 5.3 | 1125 | 675 | 5.2 | 4.3 | 1.2 | 21.2 | 1390 | 830 | — | — | — | — | — | — |
| M112-FJ12 | 6 | TERM. | 5.5 | 3.66 | 6.1 | 0.6 | 5.3 | 1125 | 675 | 5.2 | 4.3 | 1.2 | 21.2 | 1390 | 830 | — | — | — | — | — | — |
| M112-FF-206 | 4 | TERM. | — | — | — | — | — | — | — | 2.95 | 6 | 0.49 | 8.8 | 1390 | — | — | — | — | — | — | — |
| M112-FF-401 | 4 | TERM. | — | — | — | — | — | — | — | 1.95 | 4 | 0.49 | 8.8 | 950 | 675 | — | — | — | — | — | — |
| MX112-FF-401 | 4 | TERM. | — | — | — | — | — | — | — | 1.95 | 4 | 0.49 | 8.8 | 950 | 675 | — | — | — | — | — | — |
| M112-FJ326* | 6 | TERM. | 6 | 1.52 | 15.2 | 0.1 | 0.88 | 1125 | 675 | 2.15 | 10.75 | 0.2 | 3.52 | 1390 | 830 | — | — | — | — | — | — |
| M112-FJ-327* | 6 | TERM. | 6 | 2.26 | 9.2 | 0.246 | 2.2 | 1125 | 675 | 3.2 | 6.5 | 0.492 | 8.8 | 1390 | 830 | — | — | — | — | — | — |
| M112-FJ-335(5)* | 6 | TERM. | 6 | 2.26 | 9.2 | 0.246 | 2.2 | 1125 | 675 | 3.2 | 6.5 | 0.492 | 8.8 | 1390 | 830 | — | — | — | — | — | — |
| M112-FJ-344(5)* | 6 | TERM. | 6 | 1.52 | 15.2 | 0.1 | 0.88 | 1125 | 675 | 2.15 | 10.75 | 0.2 | 3.52 | 1390 | 830 | — | — | — | — | — | — |
| M112-FJ-8008* | 8 | TERM. | 7 | 5.8 | 3.8 | 1.53 | 14 | 1125 | 675 | 8.25 | 2.7 | 3.06 | 56 | 1390 | 830 | 4.1 | 5.4 | 0.765 | 14 | 1390 | 830 |
| M112-FD-8012* | 8 | TERM. | 5.5 | 3.66 | 6.1 | 0.6 | 5.3 | 1125 | 675 | 5.2 | 4.3 | 1.2 | 21.2 | 1390 | 830 | 2.6 | 8.6 | 0.3 | 5.3 | 1390 | 830 |
| M112-FJ-8012 | 8 | TERM. | 5.5 | 3.66 | 6.1 | 0.6 | 5.3 | 1125 | 675 | 5.2 | 4.3 | 1.2 | 21.2 | 1390 | 830 | 2.6 | 8.6 | 0.3 | 5.3 | 1390 | 830 |
| M112-FJ-8018* | 8 | TERM. | 6 | 2.1 | 9.2 | 0.242 | 2.1 | 1125 | 675 | 3 | 6.5 | 0.483 | 8.4 | 1390 | 830 | 1.5 | 13 | 0.12 | 2.1 | 1390 | 830 |
| M112-FJ-8025* | 8 | TERM. | 6 | 1.75 | 12.7 | 0.137 | 1 | 1125 | 675 | 2.5 | 9 | 0.274 | 4 | 1390 | 830 | 1.25 | 18 | 0.069 | 1 | 1390 | 830 |
| M112-FJ-8030* | 8 | TERM. | 6 | 1.52 | 15.2 | 0.1 | 0.88 | 1125 | 675 | 2.15 | 10.75 | 0.2 | 3.52 | 1390 | 830 | 1.1 | 21.5 | 0.05 | 0.88 | 1390 | 830 |
| M113-FF-401 | 4 | TERM. | — | — | — | — | — | — | — | 4.5 | 6 | 0.75 | 17 | 2150 | 1290 | — | — | — | — | — | — |
| M172-FD-306* | 6 | TERM. | 24 | 2.35 | 15 | 0.15 | 1.98 | 2700 | 1600 | 3.3 | 10.6 | 0.3 | 7.92 | 3300 | 1980 | — | — | — | — | — | — |
| M172-FD-308* | 6 | TERM. | 24 | 1.45 | 20 | 0.075 | 1.06 | 2700 | 1600 | 2.1 | 14.1 | 0.15 | 4.24 | 3300 | 1980 | — | — | — | — | — | — |
| M172-FF-401 | 4 | TERM. | — | — | — | — | — | — | — | 2.6 | 4 | 0.65 | 14.6 | 2000 | 1200 | — | — | — | — | — | — |
| M172-FD-8030 | 8 | TERM. | 24 | 2.35 | 15 | 0.15 | 1.98 | 2700 | 1600 | 3.3 | 10.6 | 0.3 | 7.92 | 3300 | 1980 | 1.7 | 21.5 | 0.075 | 1.98 | 3300 | 1980 |
| M172-FD-8040* | 8 | TERM. | 24 | 1.45 | 20 | 0.075 | 1.06 | 2700 | 1600 | 2.1 | 14.1 | 0.15 | 4.24 | 3300 | 1980 | 1 | 28.3 | 0.0375 | 1.06 | 3300 | 1980 |

(1) With 24 volts drive.

(2) Values shown are for reference only and are correct to the best of our knowledge at the time of publication, but are subject to change without notice. Parameters to be used as part of a specification should be verified with the factory.

(3) Voltage shown is per phase at rated current at zero steps per second, with winding at 25°C. Resistance tolerance and winding temperature will influence voltage.

(4) Tolerance is ±20%. Measured at 1 kHz with a General Radio #1650B impedance bridge having a 1 volt rms open circuit sinusoidal signal. Rotor position preconditioned by energizing same phase, then deenergizing same phase during measurement without changing rotor position.

(5) Has double end shaft.

* These motors are obsolete and should not be used in a new application design. They can be provided to support existing systems.

Specifications, MH112 and MH172 Motors

| | | | Thermal Resistance (°C/Watt) | | | | | | Series Connection | | | | | | Parallel Connection | | | | | |
|-------------------------|-------------|-------|---|------------------------|--------------------|-----------------------------|------------------------|------------------------|-------------------|--------|---------|-------|---|------|---------------------|---------|---------|-------|--|-------|
| Motor 5% Accuracy | Connections | | Typical Time For Single Step (mS) | Winding To Frame | Frame To Air | Frame To Heat Sink | Temperature Winding | Limit (°C) Frame | Volts | Ampere | R(ohms) | L(mH) | Minimum Holding Torque (2Ø ON) OZ-IN (Ncm) | | Volts | Amperes | R(ohms) | L(mH) | Minimum Holding Torque OZ-IN (Ncm) | |
| | Number | Type | | | | | | | | | | | Min. | Typ. | | | | | 2Ø ON | 1Ø ON |
| MH112-FJ-8020 | 8 | TERM. | 3 | 0.8 | 1.87 | 4.1 | 155 | 125 | 3.8 | 7.1 | 0.532 | 11.92 | 1760 | 2400 | 1.9 | 14.1 | 0.133 | 2.98 | 1760 | 2400 |
| MH112-FJ-8030 | 8 | TERM. | 2.8 | 0.8 | 1.87 | 4.1 | 155 | 125 | 2.5 | 10.6 | 0.464 | 16.5 | 1760 | 2400 | 2.46 | 21.2 | 0.116 | 4.12 | 1760 | 2400 |
| MH112-FJ-4201 | 4 | TERM. | — | 0.8 | 1.87 | 4.1 | 155 | 125 | 3.2 | 4 | 0.8 | 16.8 | 1500 | 2100 | — | — | — | — | — | — |
| MH112-FF-206 | 4 | TERM. | — | — | — | — | 130 | 100 | 4.8 | 6 | 0.8 | 16.8 | 2000 | — | — | — | — | — | — | — |
| MH172-FD-8030 | 8 | TERM. | 4.2 | 0.47 | 1.06 | 1.4 | 155 | 125 | 3.25 | 10.614 | 0.306 | 8.48 | 5300 | 6800 | 1.6 | 21.2 | 0.0765 | 2.12 | 5330 | 6800 |
| MH172-FD-8040* | 8 | TERM. | 4 | 0.47 | 1.06 | 1.4 | 155 | 125 | 2.25 | 14.4 | 0.156 | 4.76 | 5330 | 6800 | 1.15 | 28.8 | 0.039 | 1.19 | 5330 | 6800 |
| MH172-FD-4201 | 4 | TERM. | — | 0.47 | 1.06 | 1.4 | 155 | 125 | 2.64 | 1 | 0.66 | 15.6 | 3000 | 4200 | — | — | — | — | — | — |

* These motors are obsolete and should not be used in a new application design. They can be provided to support existing systems.

SLO-SYN[®] DC

KML Series High Torque Step Motors

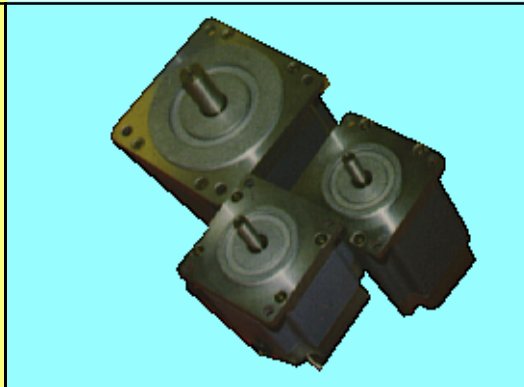
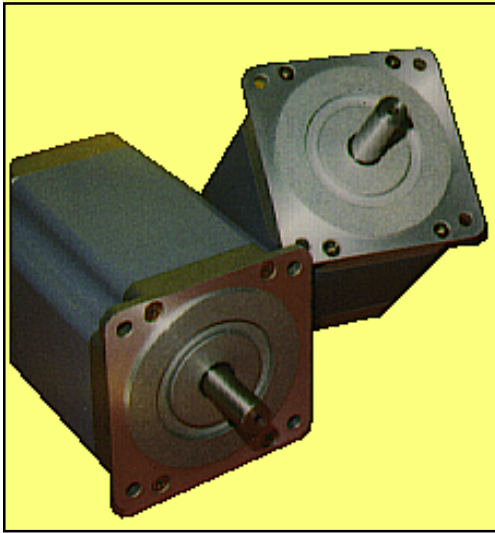

Superior Electric SLO-SYN — long recognized as the leader in step motor technology, has achieved new levels of performance with its high energy KM Series of stepping motors.

Utilizing the latest in design and magnetic technologies, the KM Series, produce double the torque of their predecessors. This achievement allows the user to reduce the size and weight of the motor, in-

crease system performance, improve productivity and reduce cost.

The KM Series is available with a variety of windings and is compatible with nearly all available step motor drives. Specific winding configurations provide a perfect match to Superior's full, half, and micro step drive packages.

Produced in an ISO9001 environment, these high technology steppers are backed with the quality and reliability of a company known for performance and value since 1938.

Features

- **7 sizes with holding torque ratings from 68 to 1155 oz-in (48 to 816 Ncm)**
- **NEMA 23 and 34 frame sizes available**
- **± 2% typical step accuracy**
- **Operate in full-step (1.8°) or half-step (0.9°) increments**
- **Can be microstepped to achieve increments as small as .0072°**
- **Can operate at rates to 20,000 steps per second (6000 rpm)**
- **UL and Canadian Recognized**
- **CE certification pending**
- **Up to 200% rated torque reserve capacity for peak performance (limited duty cycle)**
- **Can withstand over 2 times rated current without demagnetization**
- **Motors with double end shafts are provided with holes in rear end bell for encoder mounting**
- **Wide range of windings available with 4 or 6 connections for use with bipolar or unipolar drives**
- **Rugged construction to provide long life**
- **Standard terminal box, encoders, and precision gearheads available**

KML06 (NEMA 23) and KML09 (NEMA 31) Ratings & Specifications

| Motor Type | No. of Leads | Current (amps) | Voltage (VDC) | Resistance (ohms) | Inductance (mH) | Holding Torque 2-on at Rated Current (typical) oz-in (Ncm) | | Rotor Inertia oz-in-sec ² (kg-cm ²) | Maximum Overhang Load lbs (kg) | Maximum Thrust Load lbs (kg) | Residual Torque (typical) oz-in (Ncm) | Typical Motor Weight lbs (kg) |
|------------|--------------|----------------|---------------|-------------------|-----------------|--|------------|--|--------------------------------|------------------------------|---------------------------------------|-------------------------------|
| | | | | | | Unipolar | Bipolar | | | | | |
| KML060F02 | 4 | 1.05 | 3.76 | 3.58 | 15.8 | — | 68 (48) | .00154 (.108) | 15 (6.81) | 25 (11.35) | 2 (1.41) | 1.03 (.47) |
| KML060F05 | 4 | 2.7 | 1.71 | .636 | 2.53 | | | | | | | |
| KML060F08 | 4 | 4.0 | 1.11 | .277 | 1.0 | | | | | | | |
| KML060F11 | 4 | 5.3 | 0.986 | .186 | .632 | | | | | | | |
| KML060S03 | 6 | 1.48 | 2.85 | 1.93 | 3.95 | 54(38) | — | | | | | |
| KML060S08 | 6 | 3.8 | 1.28 | .336 | .632 | | | | | | | |
| KML061F02 | 4 | 1.05 | 5.19 | 4.94 | 30.1 | — | 170 (120) | .0034 (.24) | 15 (6.81) | 25 (11.35) | 3 (2.11) | 1.6 (0.73) |
| KML061F03 | 4 | 1.4 | 4.19 | 3.0 | 15.5 | | | | | | | |
| KML061F05 | 4 | 2.7 | 2.3 | .851 | 5.07 | | | | | | | |
| KML061F11 | 4 | 5.4 | 1.34 | .248 | 1.14 | | | | | | | |
| KML061S02 | 6 | 1.0 | 6.44 | 6.44 | 17.79 | 128 (90.4) | — | | | | | |
| KML061S04 | 6 | 2.06 | 3.0 | 1.46 | 3.50 | | | | | | | |
| KML061S08 | 6 | 3.8 | 1.74 | .459 | 1.10 | | | | | | | |
| KML062F03 | 4 | 1.5 | 4.40 | 2.93 | 16.9 | — | 250 (177) | .0056 (.395) | 15 (6.81) | 25 (11.35) | 6 (4.24) | 2.3 (1.04) |
| KML062F05 | 4 | 2.5 | 3.13 | 1.25 | 7.14 | | | | | | | |
| KML062F07 | 4 | 3.3 | 2.48 | .75 | 3.38 | | | | | | | |
| KML062F13 | 4 | 6.6 | 1.40 | .212 | .847 | | | | | | | |
| KML062S04 | 6 | 2.12 | 3.11 | 1.47 | 4.22 | 188 (134) | — | | | | | |
| KML062S06 | 6 | 3.0 | 2.81 | .936 | 2.51 | | | | | | | |
| KML062S09 | 6 | 4.67 | 1.75 | .375 | .845 | | | | | | | |
| KML063F03 | 4 | 1.5 | 6.07 | 4.05 | 23.9 | — | 350 (247) | .0084 (.593) | 15 (6.81) | 25 (11.35) | 7 (4.94) | 3.2 (1.45) |
| KML063F04 | 4 | 1.8 | 5.0 | 2.75 | 17.0 | | | | | | | |
| KML063F07 | 4 | 3.3 | 3.29 | .997 | 5.2 | | | | | | | |
| KML063F13 | 4 | 6.6 | 1.85 | .280 | 1.54 | | | | | | | |
| KML063S04 | 6 | 2.12 | 4.28 | 2.02 | 5.97 | 263 (186) | — | | | | | |
| KML063S09 | 6 | 4.67 | 2.52 | .540 | 1.57 | | | | | | | |
| KML091F05 | 4 | 2.7 | 3.0 | 1.11 | 11.4 | — | 385 (272) | .016 (1.13) | 25 (11.35) | 50 (22.7) | 10 (7.06) | 3.8 (1.73) |
| KML091F07 | 4 | 3.3 | 2.52 | .764 | 7.52 | | | | | | | |
| KML091F13 | 4 | 6.6 | 1.26 | .191 | 1.88 | | | | | | | |
| KML091S02 | 6 | 1.0 | 9.28 | 9.28 | 47.45 | | | | | | | |
| KML091S06 | 6 | 3.1 | 2.91 | .94 | 4.70 | 305 (215) | — | | | | | |
| KML091S08 | 6 | 3.8 | 2.1 | .553 | 2.85 | | | | | | | |
| KML091S09 | 6 | 4.67 | 1.78 | .382 | 1.88 | — | 770 (544) | .031 (2.19) | 25 (11.35) | 50 (22.7) | 15 (10.6) | 6.2 (2.82) |
| KML092F07 | 4 | 3.25 | 3.48 | 1.07 | 11.2 | | | | | | | |
| KML092F13 | 4 | 6.5 | 1.74 | .268 | 2.86 | | | | | | | |
| KML092S09 | 6 | 4.6 | 2.46 | .535 | 2.80 | 610 (431) | — | | | | | |
| KML093F07 | 4 | 3.4 | 4.9 | 1.44 | 17.9 | — | 1155 (816) | .047 (3.32) | 25 (11.35) | 50 (22.7) | 23 (16.2) | 8.7 (3.95) |
| KML093F08 | 4 | 4.0 | 3.95 | .988 | 12.8 | | | | | | | |
| KML093F10 | 4 | 5.1 | 3.21 | .629 | 8.31 | | | | | | | |
| KML093F14 | 4 | 6.8 | 2.45 | .36 | 4.48 | | | | | | | |
| KML093S07 | 6 | 3.5 | 4.41 | 1.26 | 8.31 | 915 (646) | — | | | | | |
| KML093S10 | 6 | 4.8 | 3.46 | .72 | 4.48 | | | | | | | |

SLO-SYN[®] Gearheads

Gearhead Models

Many applications have need for high torque or smaller step angles than are possible directly driving the load from the motor shaft. SLO-SYN Gearheads are NEMA, Planetary or Right Angle speed reduction assemblies that can satisfy these requirements. They are offered in a wide range of ratios, and can be supplied integrally mounted to the motor, or as a kit for mounting to an existing motor.

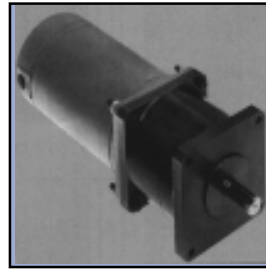

Motor with NEMA Gearhead



NEMA Gearhead Kit

They are offered with a clamp-on pinion for mounting to the motor shaft, or with a pinion designed to be pinned to the shaft for secure, permanent mounting.

SLO-SYN NEMA Gearheads

Offered for NEMA sizes 23, 34 and 42 with ratios from 3:1 to 100:1. Maximum continuous torque output is 8000 ounce-inches (5649 Ncm).

- The choice for applications requiring up to 8000 oz-in torque
- 30 arc-minutes maximum backlash at output shaft
- Seven ratios from 3:1 to 100:1
- Sturdy construction assures high positioning accuracy, long gearhead life
- Rated for 8000 oz.in (5649 Ncm) continuous torque; 16,000 oz-in (11,298 Ncm) peak torque
- 90% minimum efficiency

SLO-SYN Right Angle Gearheads

Feature high efficiency, high torque and low backlash in a space saving right angle configuration. Offered for NEMA 23, 34 and 42 frame sizes.

- Rated for 8000 oz-in (5649 Ncm) continuous torque; 16,000 oz-in (11,298 Ncm) peak torque
- 30 arc-minutes maximum backlash at output shaft
- eight ratios from 1:1 to 100:1
- Sturdily constructed, permanently lubricated for long life
- Greater than 90% efficiency

SLO-SYN Planetary Gearheads

Ideal for applications requiring high torque ratings. Offered in five ratios from 5:1 to 100:1.

- Rated for 25,600 oz-in (18,077 Ncm) continuous torque; 42,496 oz-in (30,008 Ncm) peak torque
- 10 arc-minutes maximum backlash at output shaft
- Five ratios from 5:1 to 100:1
- Constructed to assure long life, precision positioning
- 85% minimum efficiency

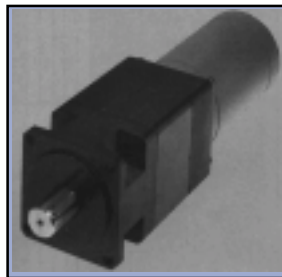

Planetary Gearhead on DC Stepper Motor

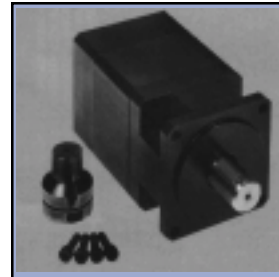

Planetary Gearhead Kit

SLO-SYN[®]

AC Synchronous Motors

Characteristics and Benefits

SLO-SYN AC Synchronous Motors offer a number of inherent characteristics that enhance operation, whether driving a load directly or when used as the power source of an AC Gearmotor. These characteristics include extremely rapid starting, stopping and reversing (within 25 milliseconds), and slow basic shaft speeds of 72 or 200 rpm at 60 hertz.



In most applications, SLO-SYN motors are used as single-phase motors, although they are actually two-phase or three-phase designs. Three-phase models need only a capacitor for phase shifting when operated from single-phase power. They can also be used with commercial inverters to achieve variable control of speed. Two-phase motors need both a resistor and a capacitor for the phase-shifting network.

Because of their high torque-to-inertia ratios, SLO-SYN motors can reach synchronous speeds within 25 milliseconds, or 5° typical. Since the connection between rotor and stator is magnetic, the motors can be stalled without damage. When this occurs, the magnetic field acts as a nonabrasive clutch which allows the rotor to stop without overheating or physical damage. A prolonged stall condition can cause gear and bearing wear however, so the motors should not be stalled for long periods of time.

SLO-SYN AC Gearmotors

SLO-SYN AC Gearmotors utilize SLO-SYN AC Synchronous Motors combined with an in-line gear speed reduction assembly which minimizes space requirements and simplifies mounting compared with other gearmotors. The gearbox design allows the motors to be small and compact, yet provides the strength needed to handle torque up to 26 foot-pounds (35.3 newton-meters). Ratios from 3:1 to 125:1 are available. All are rated for 100 pound (45.4 kg) axial loads and 150 pound (68 kg) radial loads, so external support mechanisms and additional bearings will not be needed in most applications.

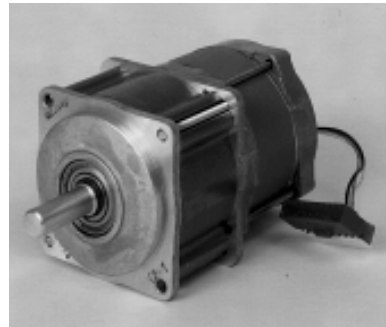

The AC Gearmotor shaft is slotted to accept a standard Woodruff key for ease of coupling and rigid mounting of the load. The gearmotors are permanently lubricated and do not require scheduled maintenance. The use of steel gears combined with the robust design of the gear assembly assures a typical operating life of 7 to 10 years.

SLO-SYN[®]

AC Synchronous Motors

Features

- High Power - allows use of a smaller motor
- Smooth, quiet operation
- Bidirectional
- Start, stop and reverse within 25 milliseconds
- Can be controlled with a single-pole, three-position switch
- Flexible coupling allows a substantial load inertia increase
- Shafts have flats or keyways standard (SS221 and larger motors only)
- Available with connectors, leads or cast terminal enclosures
- Class B insulation
- Will not overheat or be damaged if stalled
- Mating connector standard on connector models
- Single-phase requires only a simple phase-shifting network
- Can operate from two- or three-phase (depending on motor model), variable frequency supply without phase-shifting network

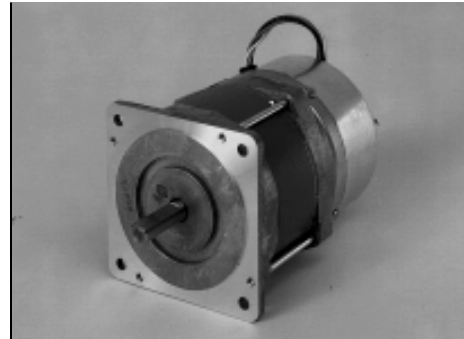

SS241C

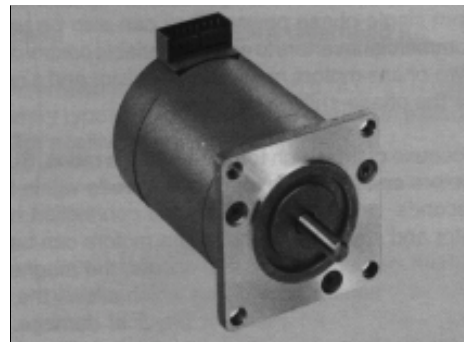

SS91/2

Typical Applications

- Automotive test equipment
- Tape dispenser
- Remote control of switches, rheostats
- X-Y positioning
- Textile edge guide controls
- Printing press ink pump control, color alignment
- Film handling
- Microfilm scanners
- Paper feed
- Furnace damper controls
- Valve control
- Timing belt drives
- Conveyor belt drives
- Card positioning
- X-Ray scanning
- Antenna rotors
- Generators
- Automated welding equipment
- Packaging machines, labeling
- Medical pumps
- Fluid metering

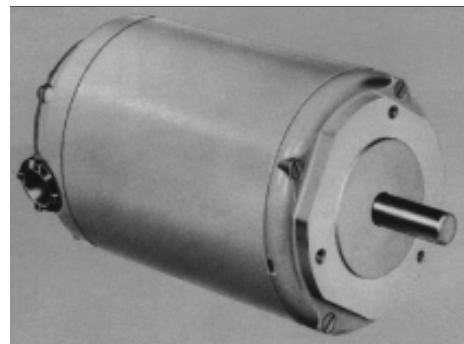

SS700

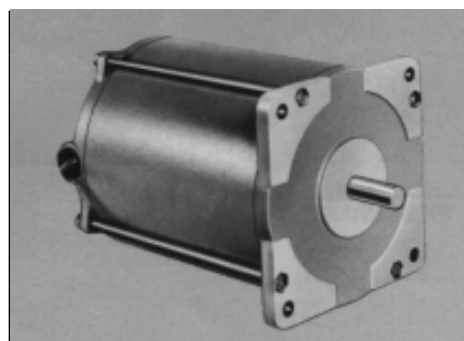

X1500

SLO-SYN[®]

AC Synchronous Gearmotors

SLO-SYN AC Gearmotors are SLO-SYN Synchronous Motors combined with step-down gearboxes for use where slow shaft speeds or high torque are needed. They feature an in-line gear speed reduction assembly that requires a minimum of space and has the strength needed to handle heavy loads. Ratios from 3:1 to 125:1 are offered. All are rated for 100 pound (45.4 kg) axial loads and 150 pound (68 kg) radial loads, so external supports or bearings are not necessary in most applications.

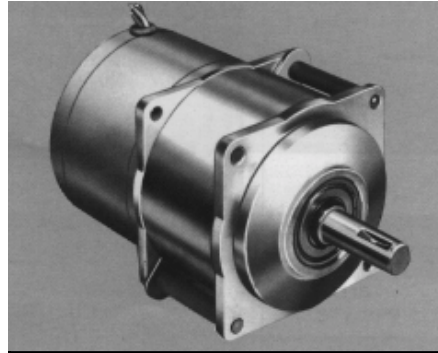

SS50-G3

The sturdy design of the gearmotors assures a typical operating life of 7 to 10 years. The gearmotors are permanently lubricated and no scheduled maintenance is needed. The output shaft of the gear assembly is slotted to accept a standard Woodruff key for easy and positive coupling to the load.

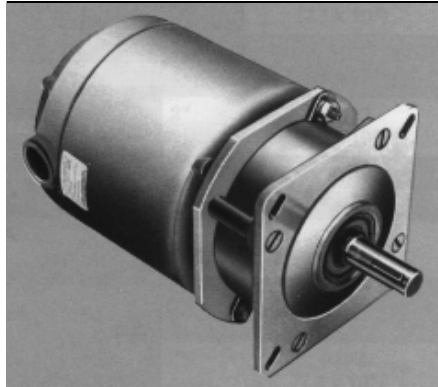

SS700-G4

Because of the unique characteristics of the SLO-SYN motor and the sturdy gearbox, the AC Gearmotor can serve as the main drive source, as a magnetic clutch, and as a DC operated brake when the motor is at a standstill. These capabilities allow the design engineer to minimize the number of system components by using the AC Gearmotor to perform several functions.

Gearbox Data

- Up to 5000 oz-in (3531 Ncm) torque
- Ratios from 3:1 to 125:1
- Efficiency to 88%
- Maintenance free
- Long operating life
- 150 pound (68 kg) radial load capacity
- 100 pound (45.4 kg) axial load capacity

The rugged gearbox developed for SLO-SYN AC Gearmotors has been designed to allow high output torque ratings while providing long life, without the need for frequent maintenance. Maximum output torque rating of the gearbox is 5000 ounce-inches (3531 Ncm). Efficiency ranges from 68% to 88%, depending on the number of stages. Nineteen ratios from 3:1 to 125:1 are offered. The Gearbox Specifications chart lists pertinent details for all available ratios.

SLO-SYN[®]

AC Synchronous Gearmotors

Features of SLO-SYN AC Gearmotors

- High power - up to 500 oz-in (3531 Ncm)
 - Slow, synchronous shaft speed
 - Bidirectional with rapid stopping or reversing
 - Can be controlled with a single-pole, three-position switch
 - Available with connectors or leads
 - Smooth, quiet operation
 - Class B insulation
 - Will not overheat if stalled
 - 150 pound (68 kg) combined radial load capacity
 - 100 pound (45.4 kg) axial load capacity
 - Efficiency to 88%, depending on gear ratio
 - Ratios from 3:1 to 125:1 available
 - 7 to 10 year gearbox life typical
-

Typical Applications

- Valve control
- timing belt drives
- Conveyor Systems
- Card positioning
- X-Ray scanning
- Antenna rotators
- Film handling
- Microfilm scanners
- Paper feed
- Furnace damper controls
- Tape dispensers
- Remote control of switches, rheostats
- X-Y positioning
- Textile edge guide controls
- Printing press ink pump control
- Generators
- Automated welding equipment
- Paper handling
- Medical pumps
- Fluid metering

SLO-SYN[®] 2000

Motion Controls

SLO-SYN Brushless Servo Motors



SLO-SYN Brushless **Servo Motors** employ resolver feedback and are precisely matched to our line of Servo amplifiers. With 23 standard motors to choose from, and torque ratings from 7.44 in-lb to 396 in-lb continuous (up to 834 in-lb peak) you can select the Servo Motor that most closely matches your performance requirements.

Superior motors are U.L. recognized, and feature high energy, neodymium-iron-boron magnets. Designed to withstand the rigors of harsh industrial environments, our motors are made with Class H insulation and are built to IP65 standards. IP67 construction is also available at a small extra charge for environments subject to heavy wash-down.

To expand your flexibility while helping you obtain enhanced on-the-job performance, Servo motors come with several optional features and configurations:

- Brakes, encoders, additional resolvers, and/or tachometers
- Special sealing and finishes
- Special shaft modifications

In addition a complete line of in-line and right angle planetary gearheads are available for use with all SLO-SYN Servo Motors. These gearheads feature high efficiency, high torque and low backlash while providing up to 8000 in-lb (904 Nm) continuous output torque, 15,000 in-lb (169 Nm) peak. Eight ratios from 3:1 to 100:1 are available to meet all applications.

Features

Servo Motors

- Neodymium-Iron-Boron (Ne Fe B) Magnets
- Built-in Resolver
- Standard NEMA Mounting
- IP65 Sealing (Standard) IP67 Optional
- UL Recognized
- Over-Temperature Sensing
- Highest Acceleration/Deceleration Capabilities
- Designed for Operation in Harsh Industrial Environments
- Long Life Design
- Smooth Low-speed Performance
- Small Package
- Numerous Optional Configurations

SERVO MOTOR RATING and SPECIFICATIONS

| Model No. | Horsepower (hp) | Kilowatts (kw) | Speed at Rated Power (RPM) | Max. operating Speed (RPM) | Continuous Torque (stall) at 104°F (40°C) | | Continuous Torque (stall) at 77°F (25°C) | | Continuous Line Current (Amps RMS) | Peak Torque | | Peak Line Current (Amps RMS) | Max. Theoretical Acceleration (rad/sec ²) | Torque Sensitivity (stall) ±10% | | Back EMF (line-to-line) ±10% (V/KRPM) | Max. line-to-line volts (Volts RMS) | DC Res at 25°C (line-to-line) ± 10% (Ohms) | Inductance line-to-line ±30% (mh) | Rotor Inertia | | Weight | | Static Friction | | Thermal Time Constant (minutes) | Viscous Damping Z Source | |
|-----------|-----------------|----------------|----------------------------|----------------------------|---|-------|--|-------|------------------------------------|-------------|--------|------------------------------|---|---------------------------------|------------|---------------------------------------|-------------------------------------|--|-----------------------------------|------------------------|-------------------|--------|-------|-----------------|-------|---------------------------------|--------------------------|---------|
| | | | | | lb-in | Nm | lb-in | Nm | | lb-in | Nm | | | lb-in/Amp RMS | Nm/Amp RMS | | | | | lb-in-sec ² | Kg-m ² | lb | kg | lb-in | Nm | | lb-in/KRP | Nm/KRPM |
| | | | | | | | | | | | | | | | | | | | | | | | | | | | | |
| S070-1L | 0.73 | 0.54 | 7,500 | 7,500 | 7.44 | 0.84 | 7.92 | 0.89 | 2.40 | 21.36 | 2.41 | 7.20 | 78,070 | 3.12 | 0.353 | 21.30 | 250 | 6.80 | 30.00 | .000274 | .000031 | 5.50 | 2.50 | 0.36 | 0.04 | 10.00 | 0.018 | 0.002 |
| S070-2L | 1.20 | 0.90 | 5,600 | 5,600 | 13.68 | 1.55 | 14.52 | 1.64 | 3.00 | 36.76 | 4.48 | 9.00 | 95,000 | 4.536 | 0.512 | 31.00 | 250 | 5.30 | 28.10 | .000408 | .0000461 | 7.00 | 3.20 | 0.48 | 0.05 | 11.00 | 0.024 | 0.0027 |
| S070-3L | 1.20 | 0.90 | 4,200 | 4,200 | 19.44 | 2.20 | 20.64 | 2.33 | 3.00 | 54.72 | 6.18 | 9.00 | 80,850 | 6.396 | 0.723 | 43.70 | 250 | 6.50 | 37.50 | .0006768 | .0000765 | 8.50 | 3.90 | 0.60 | 0.07 | 12.00 | 0.036 | 0.004 |
| S070-3M | 2.00 | 1.49 | 7,500 | 7,500 | 19.68 | 2.22 | 20.88 | 2.36 | 6.00 | 56.16 | 6.35 | 18.00 | 82,980 | 3.288 | 0.370 | 22.50 | 250 | 1.60 | 9.40 | .0006768 | .0000765 | 8.50 | 3.90 | 0.60 | 0.07 | 12.00 | 0.036 | 0.004 |
| S092-1M | 1.30 | 1.00 | 3,800 | 3,800 | 21.60 | 2.44 | 22.92 | 2.59 | 3.00 | 65.40 | 7.38 | 9.60 | 74,150 | 7.164 | 0.81 | 49.00 | 250 | 7.00 | 68.00 | .000882 | .0000996 | 9.00 | 4.10 | 0.72 | 0.08 | 18.00 | 0.06 | 0.007 |
| S092-1H | 2.00 | 1.50 | 6,200 | 6,200 | 21.60 | 2.44 | 22.92 | 2.59 | 5.00 | 67.80 | 7.65 | 16.60 | 76,870 | 4.296 | 0.486 | 29.40 | 250 | 2.34 | 25.00 | .000882 | .0001 | 9.00 | 4.10 | 0.72 | 0.08 | 18.00 | 0.06 | 0.007 |
| S092-2M | 2.10 | 1.57 | 3,600 | 3,600 | 39.60 | 4.47 | 42.00 | 4.74 | 5.30 | 122.40 | 13.80 | 17.20 | 80,000 | 7.50 | 0.848 | 51.20 | 250 | 2.48 | 38.00 | .00153 | .0001729 | 13.60 | 6.20 | 0.84 | 0.10 | 20.00 | 0.084 | 0.009 |
| S092-2H | 3.80 | 2.83 | 6,200 | 6,200 | 42.36 | 4.79 | 44.88 | 5.07 | 9.80 | 121.20 | 13.70 | 29.50 | 79,216 | 4.332 | 0.49 | 29.60 | 250 | 0.786 | 12.00 | .00153 | .0001729 | 13.60 | 6.20 | 0.84 | 0.10 | 20.00 | 0.084 | 0.009 |
| S092-3M | 2.51 | 1.80 | 2,800 | 2,800 | 55.20 | 6.24 | 58.56 | 6.62 | 5.80 | 176.40 | 19.90 | 19.50 | 79,331 | 9.528 | 1.077 | 65.10 | 250 | 2.32 | 32.00 | .002224 | .000251 | 16.70 | 7.60 | 0.96 | 0.11 | 21.00 | 0.108 | 0.012 |
| S092-3H | 3.80 | 2.83 | 4,900 | 4,900 | 57.00 | 6.44 | 60.48 | 6.83 | 10.00 | 172.80 | 19.50 | 33.00 | 77,712 | 5.52 | 0.624 | 37.70 | 250 | 0.82 | 11.00 | .002224 | .000251 | 16.70 | 7.60 | 0.96 | 0.11 | 21.00 | 0.108 | 0.012 |
| S115-1L | 1.30 | 0.97 | 1,500 | 1,500 | 60.00 | 6.80 | 63.60 | 7.20 | 3.00 | 175.20 | 19.80 | 9.30 | 61,344 | 19.92 | 2.52 | 136.10 | 250 | 10.54 | 220.00 | .002856 | .000323 | 18.50 | 8.40 | 2.16 | 0.24 | 22.00 | 0.132 | 0.015 |
| S115-1M | 2.90 | 2.20 | 3,000 | 3,000 | 62.40 | 7.00 | 66.00 | 7.40 | 6.40 | 175.20 | 19.80 | 18.80 | 61,344 | 9.84 | 1.11 | 67.20 | 250 | 2.60 | 50.00 | .002856 | .000323 | 18.50 | 8.40 | 2.16 | 0.24 | 22.00 | 0.132 | 0.015 |
| S115-1H | 3.80 | 2.80 | 5,000 | 5,000 | 57.60 | 6.50 | 61.20 | 6.90 | 9.80 | 175.20 | 19.80 | 31.30 | 61,344 | 5.88 | 0.66 | 40.20 | 250 | 0.97 | 21.00 | .002856 | .000323 | 18.50 | 8.40 | 2.16 | 0.24 | 22.00 | 0.132 | 0.015 |
| S115-2M | 4.50 | 3.40 | 2,500 | 2,500 | 117.60 | 13.30 | 124.80 | 14.10 | 9.90 | 324.00 | 36.60 | 28.80 | 55,785 | 11.88 | 1.34 | 81.20 | 250 | 1.32 | 33.50 | .005808 | .000656 | 27.50 | 12.50 | 2.28 | 0.26 | 25.00 | 0.156 | 0.018 |
| S115-2H | 7.30 | 5.40 | 5,000 | 5,000 | 116.40 | 13.10 | 123.60 | 13.90 | 19.80 | 312.00 | 35.30 | 55.90 | 53,719 | 5.88 | 0.66 | 40.20 | 250 | 0.34 | 8.40 | .005808 | .000656 | 27.50 | 12.50 | 2.28 | 0.26 | 25.00 | 0.156 | 0.018 |
| S115-3L | 3.90 | 2.90 | 1,700 | 1,700 | 156.00 | 17.60 | 165.60 | 18.70 | 9.50 | 429.60 | 48.50 | 27.30 | 52,263 | 16.56 | 1.868 | 113.20 | 250 | 1.70 | 42.00 | .00822 | .000929 | 35.00 | 15.90 | 2.544 | 0.287 | 28.00 | 0.18 | 0.020 |
| S115-3M | 7.40 | 5.50 | 3,200 | 3,200 | 164.40 | 18.60 | 175.00 | 19.70 | 19.10 | 438.00 | 49.50 | 53.30 | 53,285 | 8.64 | 0.98 | 58.80 | 250 | 0.44 | 12.00 | .00822 | .000929 | 35.00 | 15.90 | 2.544 | 0.287 | 28.00 | 0.18 | 0.020 |
| S142-1M | 7.70 | 5.70 | 4,000 | 4,000 | 153.60 | 17.40 | 163.20 | 18.40 | 20.00 | 440.40 | 49.80 | 61.40 | 48,417 | 7.548 | 0.853 | 51.60 | 250 | 0.382 | 9.00 | .009096 | .001028 | 37.00 | 16.80 | 4.32 | 0.49 | 28.00 | 0.636 | 0.072 |
| S142-2L | 8.00 | 5.97 | 2,150 | 2,150 | 266.40 | 30.10 | 282.00 | 31.90 | 19.00 | 764.40 | 86.40 | 57.40 | 42,467 | 14.016 | 1.584 | 95.78 | 250 | 0.508 | 13.30 | .018 | .0020374 | 51.00 | 23.10 | 4.56 | 0.52 | 33.00 | 0.96 | 0.109 |
| S142-2M | 12.00 | 8.95 | 3,150 | 3,150 | 266.40 | 30.10 | 282.00 | 31.90 | 27.70 | 776.90 | 87.70 | 84.80 | 43,133 | 9.636 | 1.089 | 65.85 | 250 | 0.234 | 6.30 | .018 | .002034 | 51.00 | 23.10 | 4.56 | 0.52 | 33.00 | 0.96 | 0.109 |
| S142-3L | 8.80 | 6.56 | 1,550 | 1,550 | 393.00 | 44.80 | 408.00 | 47.40 | 20.00 | 1166.40 | 131.90 | 62.00 | 43,393 | 19.821 | 2.239 | 135.40 | 250 | 0.50 | 15.60 | .02688 | .00304 | 66.00 | 29.90 | 8.328 | 0.941 | 38.00 | 1.296 | 0.147 |
| S142-3M | 15.00 | 11.20 | 3,050 | 3,050 | 393.00 | 44.80 | 408.00 | 47.40 | 40.00 | 1116.00 | 126.10 | 118.60 | 41,518 | 9.912 | 1.12 | 67.70 | 250 | 0.14 | 3.80 | .02688 | .00304 | 66.00 | 29.90 | 8.328 | 0.941 | 38.00 | 1.296 | 0.147 |
| S190-1M | 13.60 | 10.10 | 2,750 | 2,750 | 360.00 | 40.70 | 381.60 | 43.10 | 32.40 | 1143.60 | 129.20 | 108.20 | 26,472 | 11.124 | 1.257 | 76.00 | 250 | 0.20 | 9.40 | .0432 | .00488 | 79.00 | 36.00 | 5.64 | 0.64 | 40.00 | 2.10 | 0.237 |

SLO-SYN[®] 2000

Motion Controls

LIS - Light Industrial Servo Motors

The LIS series of Light Industrial Servo motors are permanent magnet brushless servo motors engineered for high performance in a compact package. LIS motors provide from 5.5 to 37.5 lb-in (.6 to 4.2 Nm) continuous torque and 17.6 to 126 lb-in (2 to 14 Nm) peak torque. The LIS Series of Servo Motors are mechanically equivalent to NEMA 23 and NEMA 34 step motors providing the perfect solution when upgrading new or existing stepper systems to servo performance. LIS motors employ rare earth magnets and low inertia rotors providing rapid acceleration and deceleration capabilities.



Features

- **NEMA 23 and NEMA 34 standard frame size**
- **6.94 to 46.56 lb-in (0.8 to 5.3 Nm) continuous stall torque**
- **1000 LPR differential encoder included**
- **Standard Hall Effect commutation**
- **Twist on connectors standard**
- **IP40 sealing**
- **UL Recognized**

MOTOR SPECIFICATIONS

| Motor | Power HP (W) | Rated Torque Cont. Lb-in (Nm) | Stall Torque Cont. Lb-in (Nm) | Peak Stall Torque Lb-in (Nm) | Current Cont. Amp | Peak Line Current Amp | Max. Operating Speed RPM | Speed at Rated Torque RPM | Torque Sensitivity (±10%) Lb-in/Amp (Nm/Amp) | Back EMF, line-to- line (±10%) Vo-pk/ KRPM | DC Resist- ance (±10%) Ohm | Induct- ance (±30%) mH | Rotor Inertia Lb-in- sec ² (Kg-m ²) | Thrust (Axial) Load Rating Lb(Kg) | Overhang (Radial) Load Rating Lb(Kg) | Weight Lb(Kg) |
|-----------|--------------------|---|---|--|-------------------------|--------------------------------|-----------------------------------|---------------------------------------|--|--|--|---------------------------------|--|---|--|------------------|
| LIS-234-F | 0.40 (299) | 5.5 (0.621) | 6.94 (0.784) | 17.43 (1.99) | 3.89 | 11.7 | 6000 | 4600 | 1.78 (0.201) | 23.9 | 2.3 | 4.63 | 0.000204 (0.000023) | 10 (4.5) | 15 (7) | 2.8 1.27 |
| LIS-342-J | 0.63 (470) | 8.0 (0.904) | 11.19 (1.26) | 30.19 (3.41) | 4.96 | 14.9 | 6000 | 5000 | 2.26 (0.255) | 30.3 | 1.86 | 8.8 | 0.000424 (0.000048) | 30 (14) | 50 (23) | 3.92 (1.78) |
| LIS-344-K | 1.08 (809) | 13.69 (1.55) | 18.9 (2.13) | 46.56 (5.26) | 5.9 | 16.3 | 6000 | 5000 | 3.17 (0.358) | 42.6 | 1.40 | 8.2 | 0.000813 (0.000092) | 30 (14) | 50 (23) | 5.8 (2.65) |
| LIS-348-E | 0.94 (700) | 37.5 (4.24) | 45.56 (5.15) | 125.2 (14.14) | 9.43 | 28.8 | 6000 | 1550 | 4.83 (0.546) | 64.9 | 0.87 | 6.06 | 0.002356 (0.000266) | 30 (14) | 50 (23) | 13.9 (6.32) |

SLO-SYN[®] 2000

Motion Controls

HIS - Heavy Industrial Servo Motors

The HIS line of Heavy Industrial Servo motors are brushless permanent magnet motors designed to provide the highest performance available. Continuous torques range from 4.4 to 104 lb-in (0.5 to 11.7 Nm). Peak torque ranges from 15 to 407 lb-in (1.7 to 45.7 Nm). The HIS series of motors are available in multiple frame sizes 2.3 in., 3.4 in. and 4.5 in. and conform to NEMA 23, 34, and 42 standard mounting. Coupled with the TD/TDC series of servo amplifiers and controls HIS motors provide the features necessary to meet your servo motion control system needs.

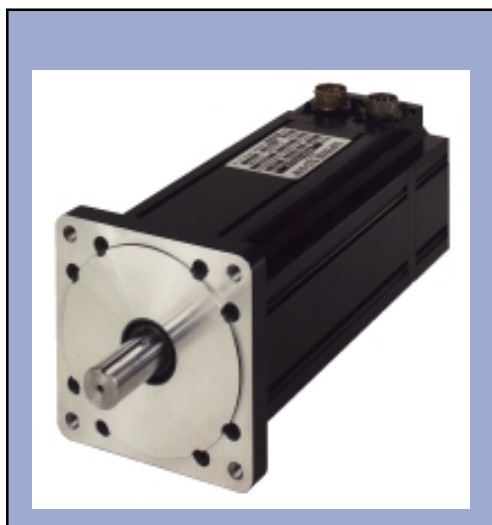

Features

- 2.3", 3.4" and 4.5" frame sizes (NEMA 23, 34, and 42 mounting)
- 1000 LPR differential encoder standard
- 2000 LPR differential encoder optional
- Commutation tracks on encoder
- 4.4 to 104 lb-in (0.5 to 11.7 Nm) continuous torque
- Thermostat protection
- MS connectors standard
- 24 VDC brake option
- IP65 sealing
- Class H winding insulation
- UL Recognized

MOTOR SPECIFICATIONS

| Motor | Power HP (W) | Rated Torque Cont. Lb-in (Nm) | Stall Torque Cont. Lb-in (Nm) | Peak Stall Torque Lb-in (Nm) | Current Cont. Amp | Peak Line Current Amp | Max. Operating Speed RPM | Speed at Rated Torque RPM | Torque Sensitivity (±10%) Lb-in/Amp (Nm/Amp) | Back EMF, line-to- line (±10%) Vo-pk/ KRPM | DC Resist- ance (±10%) Ohm | Induct- ance (±30%) mH | Rotor Inertia Lb-in- sec ² (Kg-m ²) | Thrust (Axial) Load Rating Lb(Kg) | Overhang (Radial) Load Rating Lb(Kg) | Weight Lb(Kg) |
|---------|--------------------|---|---|--|-------------------------|--------------------------------|-----------------------------------|---------------------------------------|--|--|--|---------------------------------|--|---|--|------------------|
| HIS2020 | 0.40 (300) | 6.3 (0.7) | 10 (1.1) | 30 (3.4) | 2.4 | 10.3 | 5000 | 4000 | 2.9 (0.33) | 28 | 12.1 | 16 | 0.0001 (0.00001) | 15 (7) | 20 (9) | 3.0 (1.4) |
| HIS3515 | 0.82 (620) | 13 (1.47) | 16 (1.8) | 58.8 (6.64) | 3.8 | 14.0 | 5000 | 4000 | 4.2 (0.48) | 37.6 | 3.9 | 9.1 | 0.0005 (0.00006) | 25 (11) | 40 (18) | 8.3 (3.8) |
| HIS3530 | 1.62 (1200) | 25.5 (2.9) | 30 (3.4) | 109.9 (12.42) | 7.3 | 26.8 | 5000 | 4000 | 4.1 (0.47) | 36.6 | 2.1 | 7.0 | 0.001 (0.00011) | 25 (11) | 40 (18) | 12.0 (5.4) |
| HIS3545 | 1.96 (1460) | 34.4 (3.8) | 39 (4.4) | 143.2 (16.2) | 6.3 | 23.1 | 4100 | 3600 | 6.2 (0.70) | 55 | 1.9 | 6.8 | 0.0014 (0.00016) | 25 (11) | 40 (18) | 14.6 (6.6) |
| HIS4525 | 2.1 (1600) | 45 (5.1) | 54 (6.1) | 189 (21.3) | 8.7 | 30.5 | 4200 | 3000 | 6.2 (0.71) | 55 | 0.81 | 4.5 | 0.0026 (0.00029) | 50 (23) | 100 (45) | 20.0 (9.1) |
| HIS4550 | 1.8 (1300) | 75 (8.4) | 83 (9.3) | 291 (32.7) | 6.7 | 23.4 | 2100 | 1500 | 12.4 (1.42) | 110 | 0.94 | 7.0 | 0.0051 (0.00058) | 50 (23) | 100 (45) | 28.6 (13.0) |
| HIS4575 | 2.4 (1800) | 104 (11.7) | 116 (13.1) | 407 (45.7) | 9.4 | 32.8 | 2100 | 1500 | 12.4 (1.42) | 110 | 0.5 | 4.3 | 0.0074 (0.00084) | 50 (23) | 100 (45) | 37.0 (16.8) |

Distribution Coast-To-Coast and International

Superior Electric is a global leader in the engineering, manufacturing, and marketing of precision motion and control products for industrial applications. All SLO-SYN® step motors, servo motors and controls are backed by highly specialized engineers and service people who can help solve your production challenges. Superior Electric's capabilities and products have improved operations for companies around the world.

Electro Sales provide convenient services by offering technical support, replacement parts, and literature, as well as an extensive inventory of models off-the-shelf for the fastest possible delivery. Call Electro Sales customer service for ordering and application information.

Distributed by ELECTRO SALES CO., INC.

100 Fellsway West, Somerville, MA 02145 U.S.
Phone: 617-666-0500
Fax: 617-628-2800
Toll Free: 888-789-0500

Web: <http://www.electrosales.com/warner>
E-mail: sales@electrosales.com

Superior Electric

SLO-SYN® Step/Servo Motors and Controls
POWERSTAT® Variable Transformers
SUPERCON® Electrical Connectors

LUXTROL® Lighting Controls
STABILINE® Power Protection Products
5-WAY® Binding Posts

Fincor Electronics

FINCOR® Adjustable Speed Drives
SECO® Adjustable Speed Drives

BRONCO® AC and DC Drives
NEXTDRIVE™ Adjustable Frequency Drives

Warner Engineered Systems

Integrator of **Superior Electric**, **Fincor Electronics**, and **Warner Linear** components as well as components of other manufacturers into complete motion control/drive system solutions.

Web Site: www.electrosales.com/warner



Distributed by ELECTRO SALES CO., INC.
Tel: 617-666-0500 • Fax: 617-628-2800



Superior Engineered Systems
13500-J South Point Blvd. • Charlotte, NC 28273